

37° Flared Tube Fittings



ROKE
Valves and Fittings

www.chinaroke.com

Contents

| | |
|-------------------------|------|
| Tube Cap Assembly - TCA | A-92 |
|-------------------------|------|



| | |
|----------|------|
| Nuts - N | A-92 |
|----------|------|



| | |
|----------------------|------|
| Male Connectors - CM | A-92 |
|----------------------|------|

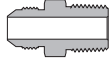

| | |
|------------------------|------|
| Female Connectors - CF | A-94 |
|------------------------|------|



| | |
|------------|------|
| Unions - U | A-95 |
|------------|------|

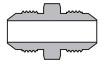

| | |
|-----------------------|------|
| Large Hex Unions - HU | A-95 |
|-----------------------|------|

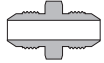

| | |
|------------------------|------|
| Reducing Adapters - RA | A-95 |
|------------------------|------|



| | |
|--------------|------|
| Sleeves - SL | A-95 |
|--------------|------|



| | |
|----------------------|------|
| Bulkhead Unions - BU | A-96 |
|----------------------|------|

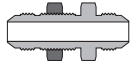

| | |
|-------------------------|------|
| Bulkhead Lock Nuts - BN | A-96 |
|-------------------------|------|



| | |
|----------------|------|
| Tube Caps - TC | A-96 |
|----------------|------|



| | |
|-----------------|------|
| Tube Plugs - TP | A-96 |
|-----------------|------|



| | |
|------------------|------|
| Male Elbows - LM | A-97 |
|------------------|------|



| | |
|-----------------------------|------|
| Adjustable Male Elbows - LP | A-97 |
|-----------------------------|------|

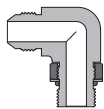

| | |
|----------------------|------|
| 45° Male Elbows - VM | A-98 |
|----------------------|------|

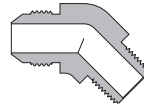

| | |
|--------------------|------|
| Female Elbows - LF | A-98 |
|--------------------|------|

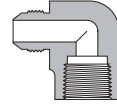

| | |
|-------------------|------|
| Union Elbows - LU | A-99 |
|-------------------|------|

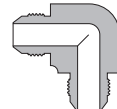

| | |
|------------------------|-------|
| Male Branch Tees - TTM | A-100 |
|------------------------|-------|

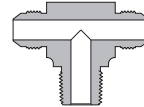

| | |
|-----------------------------------|-------|
| Adjustable Male Branch Tees - TTP | A-100 |
|-----------------------------------|-------|

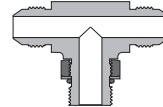

| | |
|---------------------|-------|
| Male Run Tees - TMT | A-101 |
|---------------------|-------|

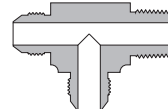

| | |
|--------------------------|-------|
| Female Branch Tees - TTF | A-101 |
|--------------------------|-------|

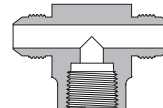

| | |
|-----------------------|-------|
| Female Run Tees - TFT | A-102 |
|-----------------------|-------|

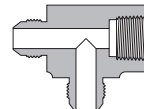

| | |
|------------------|-------|
| Union Tees - TTT | A-102 |
|------------------|-------|

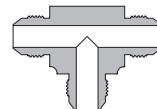

| | |
|-------------------|-------|
| Union Crosses - C | A-103 |
|-------------------|-------|

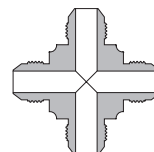

Features

- ⦿ Fittings are designed and manufactured in compliance with SAE J514
- ⦿ The hardened threads with smooth surface finish avoid galling and help to extend the fitting service life
- ⦿ Radius junction design for elbows provides smooth flow path
- ⦿ Stainless steel nut threads are silver-plated to minimize the friction with the body threads
- ⦿ Every fitting is marked with size, material and heat number
- ⦿ Fittings are easy to disconnect and retighten
- ⦿ All male threads are protected by plastic caps

Technical Data

- ⦿ Size range from 1/8" to 2" and 3 mm to 50 mm.
- ⦿ Thread Specification:

| Thread Type | Reference Specification |
|---------------|---------------------------|
| NPT | ASME B1.20.1, SAE AS71051 |
| Unified (SAE) | ASME B1.1, SAE J475 |

- ⦿ The working temperature of ROKE 37° flare tube fittings is the same as that of ROKE 6 series tube fittings.
- ⦿ Working Pressure:

| Nom. SAE Dash Size | Nom. Tube O.D. Size (in.) | 37° Flare St. Thread | SAE St. Thread Union and Bulkhead (psig/bar) |
|--------------------|---------------------------|----------------------|--|
| 2 | 1/8 | 5/16-24 | 5000 (345) |
| 3 | 3/16 | 3/8-24 | 5000 (345) |
| 4 | 1/4 | 7/16-20 | 5000 (345) |
| 5 | 5/16 | 1/2-20 | 5000 (345) |
| 6 | 3/8 | 9/16-18 | 5000 (345) |
| 8 | 1/2 | 3/4-16 | 4500 (310) |
| 10 | 5/8 | 7/8-14 | 3500 (241) |
| 12 | 3/4 | 1 1/16-12 | 3500 (241) |
| 14 | 7/8 | 1 3/16-12 | 3000 (207) |
| 16 | 1 | 1 5/16-12 | 3000 (207) |
| 20 | 1 1/4 | 1 5/8-12 | 2500 (172) |
| 24 | 1 1/2 | 1 7/8-12 | 2000 (138) |
| 32 | 2 | 2 1/2-12 | 1500 (103) |

1. Working pressures given are for fittings of stainless steel only. Contact ROKE Group or our authorized distributors for working pressure of other materials.
2. Four times safety factor applied for above working pressure.

Materials

| Material | Bar Stock | Forging | Designator |
|---------------------|---------------------------------------|--|------------|
| 316 Stainless Steel | ASTM A276 ASME SA479, EN 1.4401 | ASTM A182, ASME SA182, EN 1.4401 | SS |
| Aluminum | ASTM B211 | ASTM B247 | AL |
| Brass | ASTM B16/B453 | ASTM B283 | B |
| Carbon Steel | ASTM A108 | ASTM A105 | CS |

Ordering Information

Add the material designator as a prefix to the basic ordering number to get the complete ordering number.

For example:

1. Male connector with 1/4" tube, 1/4 NPT thread and 316 stainless steel material, the complete ordering number is **SS-CM-AN4-NS4**.
2. Sleeve with 6 mm tube and 316 stainless steel material, the complete ordering number is **SS-SL-AN6M**.

Flaring Operation

Tube flaring is carried out in two different ways, single wall flare on thick wall tubes and double wall flare on thin wall tubes to reinforce same. Refer to the table below:

Thick Tubes

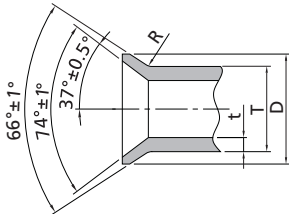

Thin Tubes

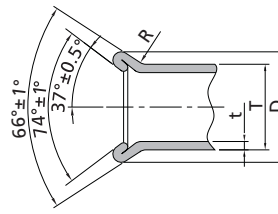

| Fractional Tubing | | | |
|----------------------|------------|-------------|--------|
| T-Tube O.D. in | Dimensions | | |
| | D (mm) | t (in.) | R (mm) |
| 1/4 | 8.6-9.1 | 0.020-0.065 | 0.8 |
| 5/16 | 10.2-10.9 | 0.020-0.065 | 0.8 |
| 3/8 | 11.6-12.4 | 0.020-0.065 | 1.0 |
| 1/2 | 16.0-16.7 | 0.028-0.083 | 1.5 |
| 5/8 | 19.3-20.0 | 0.035-0.095 | 1.5 |
| 3/4 | 23.3-24.1 | 0.035-0.109 | 2.0 |
| 7/8 | 26.4-27.1 | 0.035-0.109 | 2.0 |
| 1 | 29.7-30.4 | 0.035-0.120 | 2.3 |
| 1 1/4 | 37.5-38.3 | 0.049-0.120 | 2.3 |
| 1 1/2 | 43.2-43.9 | 0.049-0.120 | 2.8 |
| 2 | 59.2-59.9 | 0.065-0.134 | 2.8 |

| Metric Tubing | | | |
|------------------------|------------|---------|--------|
| T-Tube O.D. (mm) | Dimensions | | |
| | D (mm) | t (mm) | R (mm) |
| 6 | 8.4-9.2 | 0.5-1.5 | 0.8 |
| 8 | 10.1-10.8 | 0.5-1.5 | 0.8 |
| 10 | 12.0-12.5 | 0.5-1.5 | 1.0 |
| 12 | 16.0-16.7 | 1.0-2.0 | 1.5 |
| 14 | 18.8-19.5 | 1.0-2.5 | 1.5 |
| 15 | 19.4-20.0 | 1.0-2.5 | 1.5 |
| 16 | 19.4-20.0 | 1.0-2.5 | 1.5 |
| 18 | 23.5-24.0 | 1.0-3.0 | 2.0 |
| 20 | 24.0-24.5 | 1.0-3.0 | 2.0 |
| 22 | 26.2-27.2 | 1.0-3.0 | 2.0 |
| 25 | 29.5-30.2 | 1.0-3.0 | 2.3 |
| 30 | 37.4-38.0 | 1.5-3.0 | 2.3 |
| 32 | 37.6-38.3 | 1.5-3.0 | 2.3 |
| 38 | 43.5-44.5 | 1.5-3.0 | 2.8 |
| 50 | 58.9-59.6 | 1.5-3.5 | 2.8 |

Installation Instructions

1. Cut the tube to the proper length.
2. Insert the tube into the nut and sleeve.
3. Form the flare to 37° dimension according to SAE J533. See flaring operation.
4. Finger-tighten the nut.
5. Tighten the nut 1/4 turn with wrench while holding steady the body of the fitting.

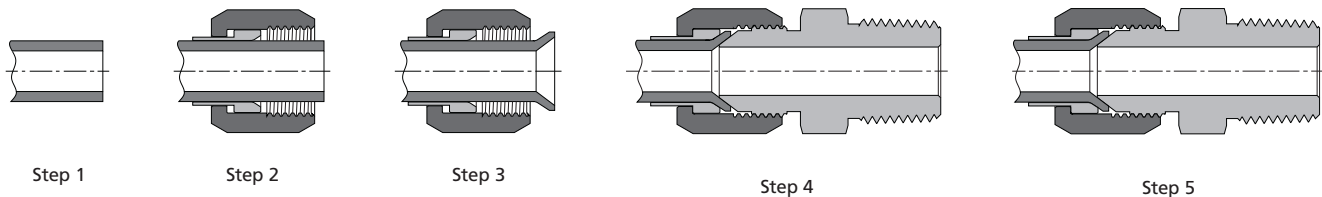

Cautions:

- ⊙ Do not loosen or tighten fittings when system is pressurized.
- ⊙ Please use proper thread sealants on tapered pipe threads.

Dimensions

Tube cap assembly

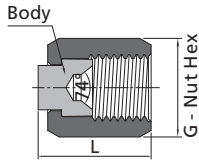

| SAE 070112A | | | | | |
|-------------|----|-----------------------|----------------------|-------------|--|
| T-Tube O.D. | | Basic Ordering Number | Dimensions, in. (mm) | | |
| in. | mm | | L | G | |
| 1/8 | 3 | -TCA-AN2 | 0.60 (15.3) | 0.37 (9.5) | |
| 3/16 | 4 | -TCA-AN3 | 0.66 (16.8) | 0.44 (11.1) | |
| 1/4 | 6 | -TCA-AN4 | 0.67 (17.1) | 0.56 (14.3) | |
| 5/16 | 8 | -TCA-AN5 | 0.77 (19.5) | 0.63 (15.9) | |
| 3/8 | 10 | -TCA-AN6 | 0.81 (20.5) | 0.69 (17.5) | |
| 1/2 | 12 | -TCA-AN8 | 0.94 (23.9) | 0.87 (22.2) | |
| 5/8 | 16 | -TCA-AN10 | 1.07 (27.1) | 1.00 (25.4) | |
| 3/4 | 18 | -TCA-AN12 | 1.24 (31.6) | 1.25 (31.8) | |
| 7/8 | 22 | -TCA-AN14 | 1.26 (32.0) | 1.37 (34.9) | |
| 1 | 25 | -TCA-AN16 | 1.29 (32.8) | 1.50 (38.1) | |
| 1 1/4 | 32 | -TCA-AN20 | 1.39 (35.4) | 2.00 (50.8) | |
| 1 1/2 | 38 | -TCA-AN24 | 1.70 (43.2) | 2.25 (57.2) | |
| 2 | 50 | -TCA-AN32 | 2.07 (52.6) | 2.87 (73.0) | |

Nuts

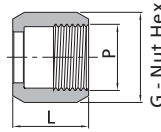

| SAE 070110 | | | | | |
|------------|----|----------------------|-----------------------|----------------------|-------------|
| Tube O.D. | | P-SAE/MS Thread Size | Basic Ordering Number | Dimensions, in. (mm) | |
| in. | mm | | | L | G |
| 1/8 | 3 | 5/16-24 | -N-AN2 | 0.55 (14.0) | 0.37 (9.5) |
| 3/16 | 4 | 3/8-24 | -N-AN3 | 0.61 (15.5) | 0.44 (11.1) |
| 1/4 | 6 | 7/16-20 | -N-AN4 | 0.62 (15.8) | 0.56 (14.3) |
| 5/16 | 8 | 1/2-20 | -N-AN5 | 0.68 (17.3) | 0.63 (15.9) |
| 3/8 | 10 | 9/16-18 | -N-AN6 | 0.73 (18.5) | 0.69 (17.5) |
| 1/2 | 12 | 3/4-16 | -N-AN8 | 0.85 (21.6) | 0.87 (22.2) |
| 5/8 | 16 | 7/8-14 | -N-AN10 | 0.98 (24.9) | 1.00 (25.4) |
| 3/4 | 18 | 1 1/16-12 | -N-AN12 | 1.03 (26.2) | 1.25 (31.8) |
| 7/8 | 22 | 1 3/16-12 | -N-AN14 | 1.09 (27.7) | 1.37 (34.9) |
| 1 | 25 | 1 5/16-12 | -N-AN16 | 1.13 (28.7) | 1.50 (38.1) |
| 1 1/4 | 32 | 1 5/8-12 | -N-AN20 | 1.23 (31.2) | 2.00 (50.8) |
| 1 1/2 | 38 | 1 7/8-12 | -N-AN24 | 1.42 (36.1) | 2.25 (57.2) |
| 2 | 50 | 2 1/2-12 | -N-AN32 | 1.75 (44.5) | 2.87 (73.0) |

Male Connectors

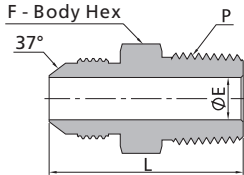

| SAE 070102 | | | | | | |
|------------|----|------------|-----------------------|----------------------|-------------|-------------|
| Tube O.D. | | P-NPT Size | Basic Ordering Number | Dimensions, in. (mm) | | |
| in. | mm | | | L | E | F |
| 1/8 | 3 | 1/8 | -CM-AN2-NS2 | 1.11 (28.2) | 0.06 (1.6) | 0.44 (11.1) |
| 3/16 | 4 | 1/8 | -CM-AN3-NS2 | 1.14 (29.0) | 0.13 (3.2) | 0.44 (11.1) |
| 1/4 | 6 | 1/8 | -CM-AN4-NS2 | 1.22 (31.0) | 0.17 (4.4) | 0.50 (12.7) |
| 1/4 | 6 | 1/4 | -CM-AN4-NS4 | 1.42 (36.0) | 0.17 (4.4) | 0.56 (14.3) |
| 1/4 | 6 | 1/2 | -CM-AN4-NS8 | 1.68 (42.7) | 0.17 (4.4) | 0.87 (22.2) |
| 5/16 | 8 | 1/8 | -CM-AN5-NS2 | 1.22 (31.0) | 0.19 (4.8) | 0.56 (14.3) |
| 5/16 | 8 | 1/4 | -CM-AN5-NS4 | 1.42 (36.1) | 0.24 (6.0) | 0.56 (14.3) |
| 3/8 | 10 | 1/8 | -CM-AN6-NS2 | 1.25 (31.8) | 0.19 (4.8) | 0.63 (15.9) |
| 3/8 | 10 | 1/4 | -CM-AN6-NS4 | 1.43 (36.3) | 0.28 (7.1) | 0.63 (15.9) |
| 3/8 | 10 | 3/8 | -CM-AN6-NS6 | 1.43 (36.3) | 0.30 (7.5) | 0.75 (19.1) |
| 3/8 | 10 | 1/2 | -CM-AN6-NS8 | 1.67 (42.5) | 0.30 (7.5) | 0.87 (22.2) |
| 1/2 | 12 | 1/4 | -CM-AN8-NS4 | 1.53 (38.9) | 0.28 (7.1) | 0.81 (20.6) |
| 1/2 | 12 | 3/8 | -CM-AN8-NS6 | 1.53 (38.9) | 0.39 (9.9) | 0.81 (20.6) |
| 1/2 | 12 | 1/2 | -CM-AN8-NS8 | 1.79 (45.5) | 0.39 (9.9) | 0.87 (22.2) |
| 1/2 | 12 | 3/4 | -CM-AN8-NS12 | 1.85 (47.0) | 0.39 (9.9) | 1.13 (28.6) |
| 5/8 | 16 | 3/8 | -CM-AN10-NS6 | 1.70 (43.1) | 0.38 (9.6) | 0.94 (23.8) |
| 5/8 | 16 | 1/2 | -CM-AN10-NS8 | 1.89 (48.0) | 0.48 (12.3) | 0.94 (23.8) |
| 5/8 | 16 | 3/4 | -CM-AN10-NS12 | 1.95 (49.5) | 0.48 (12.3) | 1.13 (28.6) |
| 3/4 | 18 | 3/4 | -CM-AN12-NS12 | 2.06 (52.3) | 0.61 (15.5) | 1.13 (28.6) |
| 3/4 | 18 | 1 | -CM-AN12-NS16 | 2.25 (57.1) | 0.61 (15.5) | 1.37 (34.9) |
| 7/8 | 22 | 3/4 | -CM-AN14-NS12 | 2.09 (53.1) | 0.62 (15.7) | 1.25 (31.8) |
| 1 | 25 | 3/4 | -CM-AN16-NS12 | 2.11 (53.5) | 0.62 (15.7) | 1.37 (34.9) |
| 1 | 25 | 1 | -CM-AN16-NS16 | 2.30 (58.4) | 0.85 (21.5) | 1.37 (34.9) |
| 1 1/4 | 32 | 1 | -CM-AN20-NS16 | 2.42 (61.5) | 0.88 (22.4) | 1.69 (42.9) |
| 1 1/4 | 32 | 1 1/4 | -CM-AN20-NS20 | 2.45 (62.2) | 1.08 (27.5) | 1.69 (42.9) |
| 1 1/2 | 38 | 1 1/4 | -CM-AN24-NS20 | 2.68 (68.1) | 1.13 (28.6) | 2.00 (50.8) |
| 1 1/2 | 38 | 1 1/2 | -CM-AN24-NS24 | 2.68 (68.1) | 1.30 (33.0) | 2.00 (50.8) |
| 2 | 50 | 2 | -CM-AN32-NS32 | 3.11 (79.0) | 1.77 (45.0) | 2.63 (66.7) |

Male Connectors

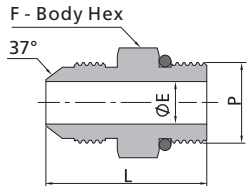

| SAE 070120 | | | | | | |
|------------|----|----------------------|-----------------------|----------------------|-------------|-------------|
| Tube O.D. | | P-SAE/MS Thread Size | Basic Ordering Number | Dimensions, in. (mm) | | |
| in. | mm | | | L | E | F |
| 1/8 | 3 | 5/16-24 | -CM-AN2-ST5 | 1.06 (26.9) | 0.06 (1.6) | 0.44 (11.1) |
| 3/16 | 4 | 3/8-24 | -CM-AN3-ST6 | 1.10 (27.9) | 0.13 (3.2) | 0.50 (12.7) |
| 1/4 | 6 | 7/16-20 | -CM-AN4-ST7 | 1.23 (31.2) | 0.17 (4.4) | 0.56 (14.3) |
| 1/4 | 6 | 1/2-20 | -CM-AN4-ST8 | 1.23 (31.2) | 0.17 (4.4) | 0.63 (15.9) |
| 1/4 | 6 | 9/16-18 | -CM-AN4-ST9 | 1.30 (33.0) | 0.17 (4.4) | 0.69 (17.5) |
| 1/4 | 6 | 3/4-16 | -CM-AN4-ST12 | 1.37 (34.8) | 0.17 (4.4) | 0.87 (22.2) |
| 5/16 | 8 | 1/2-20 | -CM-AN5-ST8 | 1.23 (31.2) | 0.24 (6.0) | 0.63 (15.9) |
| 3/8 | 10 | 9/16-18 | -CM-AN6-ST9 | 1.30 (33.0) | 0.30 (7.5) | 0.69 (17.5) |
| 3/8 | 10 | 3/4-16 | -CM-AN6-ST12 | 1.38 (35.1) | 0.30 (7.5) | 0.87 (22.2) |
| 3/8 | 10 | 7/8-14 | -CM-AN6-ST14 | 1.50 (38.1) | 0.30 (7.5) | 1.00 (25.4) |
| 1/2 | 12 | 9/16-18 | -CM-AN8-ST9 | 1.44 (36.6) | 0.30 (7.5) | 0.81 (20.6) |
| 1/2 | 12 | 3/4-16 | -CM-AN8-ST12 | 1.48 (37.6) | 0.39 (9.9) | 0.87 (22.2) |
| 1/2 | 12 | 7/8-14 | -CM-AN8-ST14 | 1.60 (40.6) | 0.39 (9.9) | 1.00 (25.4) |
| 1/2 | 12 | 1 1/16-12 | -CM-AN8-ST17 | 1.76 (44.7) | 0.39 (9.9) | 1.25 (31.8) |
| 5/8 | 16 | 3/4-16 | -CM-AN10-ST12 | 1.60 (40.6) | 0.42 (10.7) | 0.94 (23.8) |
| 5/8 | 16 | 7/8-14 | -CM-AN10-ST14 | 1.70 (43.2) | 0.48 (12.3) | 1.00 (25.4) |
| 5/8 | 16 | 1 1/16-12 | -CM-AN10-ST17 | 1.86 (47.2) | 0.48 (12.3) | 1.25 (31.8) |
| 3/4 | 18 | 3/4-16 | -CM-AN12-ST12 | 1.78 (45.2) | 0.42 (10.7) | 1.13 (28.6) |
| 3/4 | 18 | 7/8-14 | -CM-AN12-ST14 | 1.83 (46.4) | 0.50 (12.7) | 1.13 (28.6) |
| 3/4 | 18 | 1 1/16-12 | -CM-AN12-ST17 | 1.97 (50.0) | 0.61 (15.5) | 1.25 (31.8) |
| 3/4 | 18 | 1 5/16-12 | -CM-AN12-ST21 | 2.00 (50.8) | 0.61 (15.5) | 1.50 (38.1) |
| 7/8 | 22 | 1 3/16-12 | -CM-AN14-ST19 | 1.99 (50.5) | 0.72 (18.3) | 1.37 (34.9) |
| 7/8 | 22 | 1 5/16-12 | -CM-AN14-ST21 | 2.02 (51.3) | 0.72 (18.3) | 1.50 (38.1) |
| 1 | 25 | 1 1/16-12 | -CM-AN16-ST17 | 2.01 (51.1) | 0.66 (16.7) | 1.37 (34.9) |
| 1 | 25 | 1 3/16-12 | -CM-AN16-ST19 | 2.04 (51.8) | 0.72 (18.3) | 1.37 (34.9) |
| 1 | 25 | 1 5/16-12 | -CM-AN16-ST21 | 2.04 (51.8) | 0.85 (21.5) | 1.50 (38.1) |

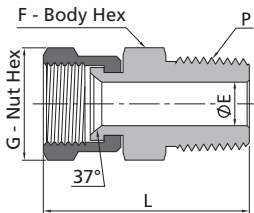

| Tube O.D. | | P-NPT Size | Basic Ordering Number | Dimensions, in. (mm) | | | |
|-----------|----|------------|-----------------------|----------------------|-------------|-------------|-------------|
| in. | mm | | | L | E | G | F |
| 1/8 | 3 | 1/8 | -CM-AS2-NS2 | 1.18 (30.0) | 0.06 (1.6) | 0.44 (11.1) | 0.44 (11.1) |
| 3/16 | 4 | 1/8 | -CM-AS3-NS2 | 1.26 (32.0) | 0.13 (3.2) | 0.50 (12.7) | 0.44 (11.1) |
| 1/4 | 6 | 1/8 | -CM-AS4-NS2 | 1.35 (34.2) | 0.17 (4.4) | 0.56 (14.3) | 0.50 (12.7) |
| 5/16 | 8 | 1/8 | -CM-AS5-NS2 | 1.38 (35.0) | 0.24 (6.0) | 0.63 (15.9) | 0.56 (14.3) |
| 3/8 | 10 | 1/4 | -CM-AS6-NS4 | 1.58 (40.2) | 0.30 (7.5) | 0.69 (17.5) | 0.63 (15.9) |
| 1/2 | 12 | 3/8 | -CM-AS8-NS6 | 1.68 (42.7) | 0.39 (9.9) | 0.87 (22.2) | 0.81 (20.6) |
| 5/8 | 16 | 1/2 | -CM-AS10-NS8 | 2.02 (51.3) | 0.48 (12.3) | 1.00 (25.4) | 0.94 (23.8) |
| 3/4 | 18 | 3/4 | -CM-AS12-NS12 | 2.15 (54.5) | 0.61 (15.5) | 1.25 (31.8) | 1.13 (28.6) |
| 7/8 | 22 | 3/4 | -CM-AS14-NS12 | 2.20 (56.0) | 0.71 (18.0) | 1.37 (34.9) | 1.25 (31.8) |
| 1 | 25 | 1 | -CM-AS16-NS16 | 2.51 (63.7) | 0.85 (21.5) | 1.50 (38.1) | 1.37 (34.9) |
| 1 1/4 | 32 | 1 1/4 | -CM-AS20-NS20 | 2.71 (68.9) | 1.08 (27.5) | 2.00 (50.8) | 1.69 (42.9) |
| 1 1/2 | 38 | 1 1/2 | -CM-AS24-NS24 | 3.06 (77.6) | 1.30 (33.0) | 2.25 (57.2) | 2.00 (50.8) |
| 2 | 50 | 2 | -CM-AS32-NS32 | 3.66 (92.9) | 1.77 (45.0) | 2.87 (73.0) | 2.63 (66.7) |

Female Connectors

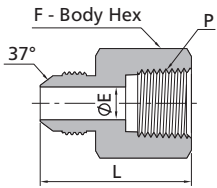

| SAE 070103 | | | | | | | |
|------------|----|------------|-----------------------|----------------------|-------------|-------------|---|
| Tube O.D. | | P-NPT Size | Basic Ordering Number | Dimensions, in. (mm) | | | F |
| in. | mm | | | L | E | F | |
| 1/8 | 3 | 1/8 | -CF-AN2-NS2 | 1.12 (28.4) | 0.06 (1.6) | 0.56 (14.3) | |
| 3/16 | 4 | 1/8 | -CF-AN3-NS2 | 1.13 (28.7) | 0.13 (3.2) | 0.56 (14.3) | |
| 1/4 | 6 | 1/8 | -CF-AN4-NS2 | 1.19 (30.2) | 0.17 (4.4) | 0.56 (14.3) | |
| 1/4 | 6 | 1/4 | -CF-AN4-NS4 | 1.39 (35.3) | 0.17 (4.4) | 0.75 (19.1) | |
| 5/16 | 8 | 1/8 | -CF-AN5-NS2 | 1.17 (29.7) | 0.24 (6.0) | 0.56 (14.3) | |
| 5/16 | 8 | 1/4 | -CF-AN5-NS4 | 1.39 (35.3) | 0.24 (6.0) | 0.75 (19.1) | |
| 3/8 | 10 | 1/4 | -CF-AN6-NS4 | 1.40 (35.6) | 0.30 (7.5) | 0.75 (19.1) | |
| 3/8 | 10 | 3/8 | -CF-AN6-NS6 | 1.46 (37.1) | 0.30 (7.5) | 0.87 (22.2) | |
| 1/2 | 12 | 3/8 | -CF-AN8-NS6 | 1.56 (39.6) | 0.39 (9.9) | 0.87 (22.2) | |
| 1/2 | 12 | 1/2 | -CF-AN8-NS8 | 1.80 (45.6) | 0.39 (9.9) | 1.13 (28.6) | |
| 5/8 | 16 | 1/2 | -CF-AN10-NS8 | 1.89 (48.0) | 0.48 (12.3) | 1.13 (28.6) | |
| 3/4 | 18 | 1/2 | -CF-AN12-NS8 | 2.05 (52.1) | 0.61 (15.5) | 1.13 (28.6) | |
| 3/4 | 18 | 3/4 | -CF-AN12-NS12 | 2.06 (52.3) | 0.61 (15.5) | 1.37 (34.9) | |
| 7/8 | 22 | 3/4 | -CF-AN14-NS12 | 2.06 (52.3) | 0.72 (18.3) | 1.37 (34.9) | |
| 1 | 25 | 1 | -CF-AN16-NS16 | 2.35 (59.7) | 0.85 (21.5) | 1.63 (41.3) | |
| 1 1/4 | 32 | 1 1/4 | -CF-AN20-NS20 | 2.49 (63.2) | 1.08 (27.5) | 2.00 (50.8) | |
| 1 1/2 | 38 | 1 1/2 | -CF-AN24-NS24 | 2.62 (66.5) | 1.30 (33.0) | 2.37 (60.3) | |
| 2 | 50 | 2 | -CF-AN32-NS32 | 2.97 (75.4) | 1.77 (45.0) | 2.87 (73.0) | |

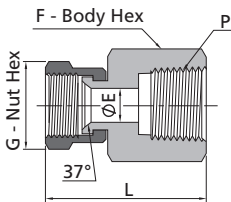

| SAE 070103 | | | | | | | |
|------------|----|------------|-----------------------|----------------------|-------------|-------------|-------------|
| Tube O.D. | | P-NPT Size | Basic Ordering Number | Dimensions, in. (mm) | | | |
| in. | mm | | | L | E | G | F |
| 1/8 | 3 | 1/8 | -CF-AS2-NS2 | 1.42 (36.1) | 0.06 (1.6) | 0.44 (11.1) | 0.56 (14.3) |
| 3/16 | 4 | 1/8 | -CF-AS3-NS2 | 1.47 (37.3) | 0.13 (3.2) | 0.50 (12.7) | 0.56 (14.3) |
| 1/4 | 6 | 1/8 | -CF-AS4-NS2 | 1.56 (39.7) | 0.17 (4.4) | 0.56 (14.3) | 0.56 (14.3) |
| 5/16 | 8 | 1/8 | -CF-AS5-NS2 | 1.59 (40.5) | 0.24 (6.0) | 0.63 (15.9) | 0.56 (14.3) |
| 3/8 | 10 | 1/4 | -CF-AS6-NS4 | 1.80 (45.8) | 0.30 (7.5) | 0.69 (17.5) | 0.75 (19.1) |
| 1/2 | 12 | 3/8 | -CF-AS8-NS6 | 1.85 (47.0) | 0.39 (9.9) | 0.87 (22.2) | 0.87 (22.2) |
| 5/8 | 16 | 1/2 | -CF-AS10-NS8 | 2.03 (51.6) | 0.48 (12.3) | 1.00 (25.4) | 1.13 (28.6) |
| 3/4 | 18 | 3/4 | -CF-AS12-NS12 | 2.62 (66.6) | 0.61 (15.5) | 1.25 (31.8) | 1.37 (34.9) |
| 7/8 | 22 | 3/4 | -CF-AS14-NS12 | 2.67 (67.8) | 0.71 (18.0) | 1.37 (34.9) | 1.37 (34.9) |
| 1 | 25 | 1 | -CF-AS16-NS16 | 2.89 (73.5) | 0.85 (21.5) | 1.50 (38.1) | 1.63 (41.3) |
| 1 1/4 | 32 | 1 1/4 | -CF-AS20-NS20 | 3.07 (78.1) | 1.08 (27.5) | 2.00 (50.8) | 2.00 (50.8) |
| 1 1/2 | 38 | 1 1/2 | -CF-AS24-NS24 | 3.41 (86.7) | 1.30 (33.0) | 2.37 (60.3) | 2.37 (60.3) |
| 2 | 50 | 2 | -CF-AS32-NS32 | 3.52 (89.3) | 1.77 (45.0) | 2.87 (73.0) | 2.63 (66.7) |

Unions

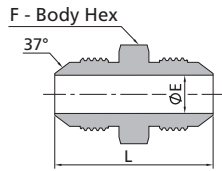

| SAE 070101 | | | | | |
|------------|----|-----------------------|----------------------|-------------|-------------|
| Tube O.D. | | Basic Ordering Number | Dimensions, in. (mm) | | |
| in. | mm | | L | E | F |
| 1/8 | 3 | -U-AN2 | 1.17 (29.7) | 0.06 (1.6) | 0.44 (11.1) |
| 3/16 | 4 | -U-AN3 | 1.23 (31.2) | 0.13 (3.2) | 0.44 (11.1) |
| 1/4 | 6 | -U-AN4 | 1.37 (34.8) | 0.17 (4.4) | 0.50 (12.7) |
| 5/16 | 8 | -U-AN5 | 1.37 (34.8) | 0.24 (6.0) | 0.56 (14.3) |
| 3/8 | 10 | -U-AN6 | 1.41 (35.8) | 0.30 (7.5) | 0.63 (15.9) |
| 1/2 | 12 | -U-AN8 | 1.62 (41.1) | 0.39 (9.9) | 0.81 (20.6) |
| 5/8 | 16 | -U-AN10 | 1.88 (47.8) | 0.48 (12.3) | 0.94 (23.8) |
| 3/4 | 18 | -U-AN12 | 2.16 (54.9) | 0.61 (15.5) | 1.13 (28.6) |
| 7/8 | 22 | -U-AN14 | 2.21 (56.1) | 0.72 (18.3) | 1.25 (31.8) |
| 1 | 25 | -U-AN16 | 2.25 (57.2) | 0.85 (21.5) | 1.37 (34.9) |
| 1 1/4 | 32 | -U-AN20 | 2.43 (61.7) | 1.08 (27.5) | 1.69 (42.9) |
| 1 1/2 | 38 | -U-AN24 | 2.75 (69.8) | 1.30 (33.0) | 2.00 (50.8) |
| 2 | 50 | -U-AN32 | 3.40 (86.4) | 1.77 (45.0) | 2.63 (66.7) |

Large Hex Unions

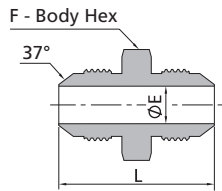

| SAE 070119 | | | | | |
|------------|----|-----------------------|----------------------|-------------|-------------|
| Tube O.D. | | Basic Ordering Number | Dimensions, in. (mm) | | |
| in. | mm | | L | E | F |
| 1/8 | 3 | -HU-AN2 | 1.17 (29.7) | 0.06 (1.6) | 0.56 (14.3) |
| 3/16 | 4 | -HU-AN3 | 1.23 (31.2) | 0.13 (3.2) | 0.63 (15.9) |
| 1/4 | 6 | -HU-AN4 | 1.37 (34.8) | 0.17 (4.4) | 0.69 (17.5) |
| 5/16 | 8 | -HU-AN5 | 1.37 (34.8) | 0.24 (6.0) | 0.75 (19.1) |
| 3/8 | 10 | -HU-AN6 | 1.41 (35.8) | 0.30 (7.5) | 0.81 (20.6) |
| 1/2 | 12 | -HU-AN8 | 1.62 (41.1) | 0.39 (9.9) | 1.00 (25.4) |
| 5/8 | 16 | -HU-AN10 | 1.88 (47.8) | 0.48 (12.3) | 1.13 (28.6) |
| 3/4 | 18 | -HU-AN12 | 2.16 (54.9) | 0.61 (15.5) | 1.37 (34.9) |
| 7/8 | 22 | -HU-AN14 | 2.21 (56.1) | 0.72 (18.3) | 1.50 (38.1) |
| 1 | 25 | -HU-AN16 | 2.25 (57.2) | 0.85 (21.5) | 1.63 (41.3) |
| 1 1/4 | 32 | -HU-AN20 | 2.43 (61.7) | 1.08 (27.5) | 1.87 (47.6) |
| 1 1/2 | 38 | -HU-AN24 | 2.75 (69.8) | 1.30 (33.0) | 2.13 (54.0) |
| 2 | 50 | -HU-AN32 | 3.40 (86.4) | 1.77 (45.0) | 2.75 (69.9) |

Reducing Adapters

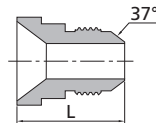

| SAE 070123 | | | | |
|------------|----------|-----------------------|------|--------|
| Tube O.D. | | Basic Ordering Number | L | |
| in.-mm | in.-mm | | in. | mm |
| 3/8-10 | 1/4-6 | -RA-AN6-AN4 | 0.97 | (24.6) |
| 1/2-12 | 1/4-6 | -RA-AN8-AN4 | 1.00 | (25.4) |
| 1/2-12 | 3/8-10 | -RA-AN8-AN6 | 1.00 | (25.4) |
| 5/8-16 | 1/4-6 | -RA-AN10-AN4 | 1.03 | (26.2) |
| 5/8-16 | 3/8-10 | -RA-AN10-AN6 | 1.03 | (26.2) |
| 3/4-18 | 1/4-6 | -RA-AN12-AN4 | 1.09 | (27.7) |
| 3/4-18 | 3/8-10 | -RA-AN12-AN6 | 1.09 | (27.7) |
| 3/4-18 | 1/2-12 | -RA-AN12-AN8 | 1.19 | (30.2) |
| 7/8-22 | 3/8-10 | -RA-AN14-AN6 | 1.13 | (28.7) |
| 7/8-22 | 5/8-16 | -RA-AN14-AN10 | 1.33 | (33.7) |
| 1-25 | 1/4-6 | -RA-AN16-AN4 | 1.22 | (31.0) |
| 1-25 | 3/8-10 | -RA-AN16-AN6 | 1.22 | (31.0) |
| 1-25 | 1/2-12 | -RA-AN16-AN8 | 1.27 | (32.3) |
| 1-25 | 5/8-16 | -RA-AN16-AN10 | 1.38 | (35.1) |
| 1-25 | 3/4-18 | -RA-AN16-AN12 | 1.47 | (37.3) |
| 1 1/4-32 | 3/4-18 | -RA-AN20-AN12 | 1.53 | (38.8) |
| 1 1/4-32 | 1-25 | -RA-AN20-AN16 | 1.59 | (40.3) |
| 1 1/2-38 | 1/2-12 | -RA-AN24-AN8 | 1.56 | (39.6) |
| 1 1/2-38 | 3/4-18 | -RA-AN24-AN12 | 1.63 | (41.4) |
| 1 1/2-38 | 1-25 | -RA-AN24-AN16 | 1.63 | (41.4) |
| 2-50 | 1 1/2-38 | -RA-AN32-AN24 | 1.91 | (48.5) |

Sleeves

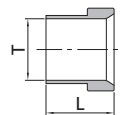

| SAE 070115 | | | | |
|-------------|----|-----------------------|-----------|-------------|
| T-Tube O.D. | | Basic Ordering Number | | L in.(mm) |
| in. | mm | in. | mm | |
| 1/8 | 3 | -SL-AN2 | -SL-AN3M | 0.34 (8.6) |
| 3/16 | 4 | -SL-AN3 | -SL-AN4M | 0.34 (8.6) |
| 1/4 | 6 | -SL-AN4 | -SL-AN6M | 0.41 (10.4) |
| 5/16 | 8 | -SL-AN5 | -SL-AN8M | 0.44 (11.2) |
| 3/8 | 10 | -SL-AN6 | -SL-AN10M | 0.50 (12.7) |
| 1/2 | 12 | -SL-AN8 | -SL-AN12M | 0.56 (14.2) |
| 5/8 | 16 | -SL-AN10 | -SL-AN16M | 0.66 (16.8) |
| 3/4 | 18 | -SL-AN12 | -SL-AN18M | 0.68 (17.3) |
| 7/8 | 22 | -SL-AN14 | -SL-AN22M | 0.76 (19.3) |
| 1 | 25 | -SL-AN16 | -SL-AN25M | 0.78 (19.8) |
| 1 1/4 | 32 | -SL-AN20 | -SL-AN32M | 0.91 (23.1) |
| 1 1/2 | 38 | -SL-AN24 | -SL-AN38M | 1.12 (28.4) |
| 2 | 50 | -SL-AN32 | -SL-AN50M | 1.19 (30.2) |

8 37° Flared Tube Fitting

Bulkhead Unions

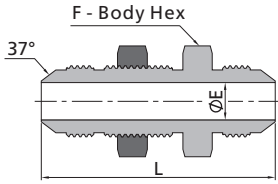

| SAE 070601 | | | | | |
|------------|----|-----------------------|----------------------|-------------|-------------|
| Tube O.D. | | Basic Ordering Number | Dimensions, in. (mm) | | |
| in. | mm | | L | E | F |
| 3/16 | 4 | -BU-AN3 | 1.90 (48.3) | 0.13 (3.2) | 0.63 (15.9) |
| 1/4 | 6 | -BU-AN4 | 2.07 (52.6) | 0.17 (4.4) | 0.69 (17.5) |
| 5/16 | 8 | -BU-AN5 | 2.07 (52.6) | 0.24 (6.0) | 0.75 (19.1) |
| 3/8 | 10 | -BU-AN6 | 2.18 (55.4) | 0.30 (7.5) | 0.81 (20.6) |
| 1/2 | 12 | -BU-AN8 | 2.44 (62.0) | 0.39 (9.9) | 1.00 (25.4) |
| 5/8 | 16 | -BU-AN10 | 2.74 (69.6) | 0.48 (12.3) | 1.13 (28.6) |
| 3/4 | 18 | -BU-AN12 | 3.09 (78.5) | 0.61 (15.5) | 1.37 (34.9) |
| 7/8 | 22 | -BU-AN14 | 3.12 (79.2) | 0.72 (18.3) | 1.50 (38.1) |
| 1 | 25 | -BU-AN16 | 3.14 (79.8) | 0.85 (21.5) | 1.63 (41.3) |
| 1 1/4 | 32 | -BU-AN20 | 3.31 (84.1) | 1.08 (27.5) | 1.87 (47.6) |
| 1 1/2 | 38 | -BU-AN24 | 3.52 (89.4) | 1.30 (33.0) | 2.13 (54.0) |
| 2 | 50 | -BU-AN32 | 4.20 (106.7) | 1.77 (45.0) | 2.75 (69.9) |

Tube Caps

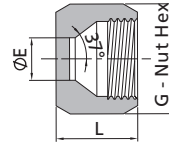

| SAE 070112 | | | | | |
|------------|----|-----------------------|----------------------|-------------|-------------|
| Tube O.D. | | Basic Ordering Number | Dimensions, in. (mm) | | |
| in. | mm | | L | E | G |
| 1/8 | 3 | -TC-AN2 | 0.50 (12.7) | 0.06 (1.6) | 0.37 (9.5) |
| 3/16 | 4 | -TC-AN3 | 0.56 (14.3) | 0.13 (3.2) | 0.44 (11.1) |
| 1/4 | 6 | -TC-AN4 | 0.59 (15.1) | 0.17 (4.4) | 0.56 (14.3) |
| 5/16 | 8 | -TC-AN5 | 0.61 (15.5) | 0.24 (6.0) | 0.63 (15.9) |
| 3/8 | 10 | -TC-AN6 | 0.63 (15.9) | 0.30 (7.5) | 0.69 (17.5) |
| 1/2 | 12 | -TC-AN8 | 0.75 (19.1) | 0.39 (9.9) | 0.87 (22.2) |
| 5/8 | 16 | -TC-AN10 | 0.84 (21.4) | 0.48 (12.3) | 1.00 (25.4) |
| 3/4 | 18 | -TC-AN12 | 0.91 (23.0) | 0.61 (15.5) | 1.25 (31.8) |
| 7/8 | 22 | -TC-AN14 | 0.97 (24.6) | 0.72 (18.3) | 1.37 (34.9) |
| 1 | 25 | -TC-AN16 | 1.02 (25.8) | 0.85 (21.5) | 1.50 (38.1) |
| 1 1/4 | 32 | -TC-AN20 | 1.06 (27.0) | 1.08 (27.5) | 2.00 (50.8) |
| 1 1/2 | 38 | -TC-AN24 | 1.19 (30.2) | 1.30 (33.0) | 2.25 (57.2) |
| 2 | 50 | -TC-AN32 | 1.44 (36.5) | 1.77 (45.0) | 2.87 (73.0) |

Bulkhead Lock Nuts

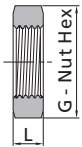

| SAE 070118 | | | | |
|------------|----|-----------------------|----------------------|-------------|
| Tube O.D. | | Basic Ordering Number | Dimensions, in. (mm) | |
| in. | mm | | L | G |
| 3/16 | 4 | -BN-AN3 | 0.22 (5.6) | 0.63 (15.9) |
| 1/4 | 6 | -BN-AN4 | 0.28 (7.1) | 0.69 (17.5) |
| 5/16 | 8 | -BN-AN5 | 0.28 (7.1) | 0.75 (19.1) |
| 3/8 | 10 | -BN-AN6 | 0.27 (6.9) | 0.81 (20.6) |
| 1/2 | 12 | -BN-AN8 | 0.31 (7.9) | 1.00 (25.4) |
| 5/8 | 16 | -BN-AN10 | 0.36 (9.1) | 1.13 (28.6) |
| 3/4 | 18 | -BN-AN12 | 0.41 (10.4) | 1.37 (34.9) |
| 7/8 | 22 | -BN-AN14 | 0.41 (10.4) | 1.50 (38.1) |
| 1 | 25 | -BN-AN16 | 0.41 (10.4) | 1.63 (41.3) |
| 1 1/4 | 32 | -BN-AN20 | 0.41 (10.4) | 1.87 (47.6) |
| 1 1/2 | 38 | -BN-AN24 | 0.41 (10.4) | 2.13 (54.0) |
| 2 | 50 | -BN-AN32 | 0.41 (10.4) | 2.75 (69.9) |

Tube Plugs

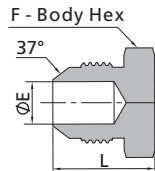

| SAE 070109 | | | | | |
|------------|----|-----------------------|----------------------|-------------|-------------|
| Tube O.D. | | Basic Ordering Number | Dimensions, in. (mm) | | |
| in. | mm | | L | E | F |
| 1/8 | 3 | -TP-AN2 | 0.70 (17.8) | 0.06 (1.6) | 0.44 (11.1) |
| 3/16 | 4 | -TP-AN3 | 0.73 (18.5) | 0.13 (3.2) | 0.44 (11.1) |
| 1/4 | 6 | -TP-AN4 | 0.80 (20.3) | 0.17 (4.4) | 0.50 (12.7) |
| 5/16 | 8 | -TP-AN5 | 0.80 (20.3) | 0.24 (6.0) | 0.56 (14.3) |
| 3/8 | 10 | -TP-AN6 | 0.84 (21.3) | 0.30 (7.5) | 0.63 (15.9) |
| 1/2 | 12 | -TP-AN8 | 0.94 (23.9) | 0.39 (9.9) | 0.81 (20.6) |
| 5/8 | 16 | -TP-AN10 | 1.10 (27.9) | 0.48 (12.3) | 0.94 (23.8) |
| 3/4 | 18 | -TP-AN12 | 1.28 (32.5) | 0.61 (15.5) | 1.13 (28.6) |
| 7/8 | 22 | -TP-AN14 | 1.31 (33.3) | 0.72 (18.3) | 1.25 (31.8) |
| 1 | 25 | -TP-AN16 | 1.33 (33.8) | 0.85 (21.5) | 1.37 (34.9) |
| 1 1/4 | 32 | -TP-AN20 | 1.45 (36.8) | 1.08 (27.5) | 1.69 (42.9) |
| 1 1/2 | 38 | -TP-AN24 | 1.65 (41.9) | 1.30 (33.0) | 2.00 (50.8) |
| 2 | 50 | -TP-AN32 | 2.05 (52.1) | 1.77 (45.0) | 2.63 (66.7) |

Male Elbows

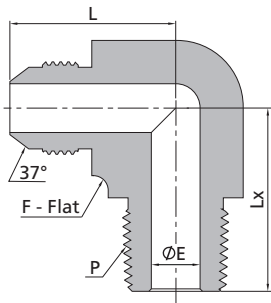

| SAE 070202 | | | | | | | | |
|------------|----|------------|-----------------------|----------------------|-------------|-------------|-------------|--|
| Tube O.D. | | P-NPT Size | Basic Ordering Number | Dimensions, in. (mm) | | | | |
| in. | mm | | | L | E | F | Lx | |
| 1/8 | 3 | 1/8 | -LM-AN2-NS2 | 0.77 (19.6) | 0.06 (1.6) | 0.44 (11.1) | 0.72 (18.3) | |
| 3/16 | 4 | 1/8 | -LM-AN3-NS2 | 0.83 (21.1) | 0.13 (3.2) | 0.44 (11.1) | 0.72 (18.3) | |
| 1/4 | 6 | 1/8 | -LM-AN4-NS2 | 0.89 (22.6) | 0.17 (4.4) | 0.50 (12.7) | 0.78 (19.8) | |
| 1/4 | 6 | 1/4 | -LM-AN4-NS4 | 1.06 (26.9) | 0.17 (4.4) | 0.56 (14.3) | 1.09 (27.7) | |
| 5/16 | 8 | 1/8 | -LM-AN5-NS2 | 0.95 (24.1) | 0.19 (4.8) | 0.56 (14.3) | 0.78 (19.8) | |
| 5/16 | 8 | 1/4 | -LM-AN5-NS4 | 1.06 (26.9) | 0.24 (6.0) | 0.56 (14.3) | 1.09 (27.7) | |
| 3/8 | 10 | 1/8 | -LM-AN6-NS2 | 1.06 (26.9) | 0.19 (4.8) | 0.56 (14.3) | 0.90 (22.8) | |
| 3/8 | 10 | 1/4 | -LM-AN6-NS4 | 1.06 (26.9) | 0.28 (7.1) | 0.56 (14.3) | 1.09 (27.7) | |
| 3/8 | 10 | 3/8 | -LM-AN6-NS6 | 1.14 (29.0) | 0.30 (7.5) | 0.69 (17.5) | 1.22 (31.0) | |
| 3/8 | 10 | 1/2 | -LM-AN6-NS8 | 1.23 (31.2) | 0.30 (7.5) | 0.81 (20.6) | 1.47 (37.3) | |
| 1/2 | 12 | 1/4 | -LM-AN8-NS4 | 1.25 (31.8) | 0.28 (7.1) | 0.81 (20.6) | 1.22 (31.0) | |
| 1/2 | 12 | 3/8 | -LM-AN8-NS6 | 1.25 (31.8) | 0.39 (9.9) | 0.81 (20.6) | 1.22 (31.0) | |
| 1/2 | 12 | 1/2 | -LM-AN8-NS8 | 1.33 (33.7) | 0.39 (9.9) | 0.81 (20.6) | 1.47 (37.3) | |
| 1/2 | 12 | 3/4 | -LM-AN8-NS12 | 1.42 (36.0) | 0.35 (9.0) | 1.00 (25.4) | 1.59 (40.4) | |
| 5/8 | 16 | 3/8 | -LM-AN10-NS6 | 1.45 (36.8) | 0.39 (9.9) | 0.81 (20.6) | 1.30 (33.0) | |
| 5/8 | 16 | 1/2 | -LM-AN10-NS8 | 1.45 (36.8) | 0.48 (12.3) | 0.81 (20.6) | 1.47 (37.3) | |
| 5/8 | 16 | 3/4 | -LM-AN10-NS12 | 1.53 (38.9) | 0.48 (12.3) | 1.00 (25.4) | 1.59 (40.4) | |
| 3/4 | 18 | 3/4 | -LM-AN12-NS12 | 1.66 (42.2) | 0.61 (15.5) | 1.06 (27.0) | 1.59 (40.4) | |
| 3/4 | 18 | 1 | -LM-AN12-NS16 | 1.66 (42.2) | 0.61 (15.5) | 1.25 (31.8) | 1.98 (50.4) | |
| 7/8 | 22 | 3/4 | -LM-AN14-NS12 | 1.80 (45.7) | 0.72 (18.3) | 1.25 (31.8) | 1.69 (42.9) | |
| 1 | 25 | 3/4 | -LM-AN16-NS12 | 1.81 (46.0) | 0.72 (18.3) | 1.37 (34.9) | 1.78 (45.2) | |
| 1 | 25 | 1 | -LM-AN16-NS16 | 1.81 (46.0) | 0.85 (21.5) | 1.37 (34.9) | 1.97 (50.0) | |
| 1 1/4 | 32 | 1 | -LM-AN20-NS16 | 2.06 (52.3) | 0.94 (23.8) | 1.69 (42.9) | 2.35 (59.6) | |
| 1 1/4 | 32 | 1 1/4 | -LM-AN20-NS20 | 2.06 (52.3) | 1.08 (27.5) | 1.69 (42.9) | 2.38 (60.5) | |
| 1 1/2 | 38 | 1 1/2 | -LM-AN24-NS24 | 2.33 (59.2) | 1.30 (33.0) | 2.00 (50.8) | 2.64 (67.1) | |
| 2 | 50 | 2 | -LM-AN32-NS32 | 3.06 (77.7) | 1.77 (45.0) | 2.50 (63.5) | 3.00 (76.2) | |

Adjustable Male Elbows

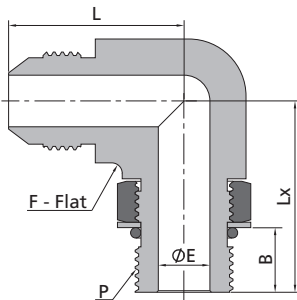

| SAE 070220 | | | | | | | | |
|------------|----|----------------------|-----------------------|----------------------|-------------|-------------|-------------|-------------|
| Tube O.D. | | P-SAE/MS Thread Size | Basic Ordering Number | Dimensions, in. (mm) | | | | |
| in. | mm | | | L | E | F | Lx | B |
| 1/8 | 3 | 5/16-24 | -LP-AN2-ST5 | 0.77 (19.6) | 0.06 (1.6) | 0.44 (11.1) | 0.94 (23.9) | 0.33 (8.4) |
| 3/16 | 4 | 3/8-24 | -LP-AN3-ST6 | 0.83 (21.1) | 0.13 (3.2) | 0.44 (11.1) | 0.94 (23.9) | 0.33 (8.4) |
| 1/4 | 6 | 7/16-20 | -LP-AN4-ST7 | 0.89 (22.6) | 0.17 (4.4) | 0.50 (12.7) | 1.03 (26.2) | 0.39 (9.8) |
| 5/16 | 8 | 1/2-20 | -LP-AN5-ST8 | 0.95 (24.1) | 0.24 (6.0) | 0.56 (14.3) | 1.13 (28.7) | 0.39 (9.8) |
| 3/8 | 10 | 9/16-18 | -LP-AN6-ST9 | 1.06 (26.9) | 0.30 (7.5) | 0.63 (15.9) | 1.25 (31.8) | 0.43 (11.0) |
| 1/2 | 12 | 3/4-16 | -LP-AN8-ST12 | 1.25 (31.8) | 0.39 (9.9) | 0.81 (20.6) | 1.45 (36.8) | 0.49 (12.5) |
| 5/8 | 16 | 7/8-14 | -LP-AN10-ST14 | 1.45 (36.8) | 0.48 (12.3) | 0.94 (23.8) | 1.70 (43.2) | 0.56 (14.2) |
| 3/4 | 18 | 1 1/16-12 | -LP-AN12-ST17 | 1.66 (42.2) | 0.61 (15.5) | 1.25 (31.8) | 1.94 (49.3) | 0.65 (16.5) |
| 7/8 | 22 | 1 3/16-12 | -LP-AN14-ST19 | 1.80 (45.7) | 0.72 (18.3) | 1.25 (31.8) | 2.00 (50.8) | 0.65 (16.5) |
| 1 | 25 | 1 5/16-12 | -LP-AN16-ST21 | 1.81 (46.0) | 0.85 (21.5) | 1.37 (34.9) | 2.05 (52.1) | 0.65 (16.5) |
| 1 1/4 | 32 | 1 5/8-12 | -LP-AN20-ST26 | 2.06 (52.3) | 1.08 (27.5) | 1.69 (42.9) | 2.25 (57.2) | 0.65 (16.5) |
| 1 1/2 | 38 | 1 7/8-12 | -LP-AN24-ST30 | 2.33 (59.2) | 1.30 (33.0) | 2.00 (50.8) | 2.39 (60.7) | 0.65 (16.5) |
| 2 | 50 | 2 1/2-12 | -LP-AN32-ST40 | 3.06 (77.7) | 1.77 (45.0) | 2.50 (63.5) | 2.89 (73.4) | 0.65 (16.5) |

45° Male Elbows

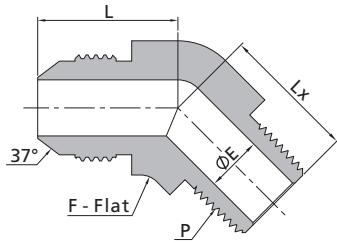

| SAE 070302 | | | | | | | |
|------------|----|------------|-----------------------|----------------------|-------------|-------------|-------------|
| Tube O.D. | | P-NPT Size | Basic Ordering Number | Dimensions, in. (mm) | | | |
| in. | mm | | | L | E | F | Lx |
| 1/8 | 3 | 1/8 | -VM-AN2-NS2 | 0.69 (17.5) | 0.06 (1.6) | 0.44 (11.1) | 0.52 (13.2) |
| 3/16 | 4 | 1/8 | -VM-AN3-NS2 | 0.69 (17.5) | 0.13 (3.2) | 0.44 (11.1) | 0.52 (13.2) |
| 1/4 | 6 | 1/8 | -VM-AN4-NS2 | 0.72 (18.3) | 0.17 (4.4) | 0.50 (12.7) | 0.64 (16.3) |
| 5/16 | 8 | 1/8 | -VM-AN5-NS2 | 0.77 (19.6) | 0.19 (4.8) | 0.56 (14.3) | 0.64 (16.3) |
| 3/8 | 10 | 1/4 | -VM-AN6-NS4 | 0.83 (21.1) | 0.28 (7.1) | 0.56 (14.3) | 0.86 (21.8) |
| 1/2 | 12 | 3/8 | -VM-AN8-NS6 | 0.98 (24.9) | 0.39 (9.9) | 0.69 (17.5) | 0.95 (24.1) |
| 5/8 | 16 | 1/2 | -VM-AN10-NS8 | 1.11 (28.2) | 0.48 (12.3) | 0.81 (20.6) | 1.17 (29.7) |
| 3/4 | 18 | 3/4 | -VM-AN12-NS12 | 1.28 (32.5) | 0.61 (15.5) | 1.06 (27.0) | 1.20 (30.5) |
| 7/8 | 22 | 3/4 | -VM-AN14-NS12 | 1.45 (36.8) | 0.72 (18.3) | 1.25 (31.8) | 1.30 (33.0) |
| 1 | 25 | 1 | -VM-AN16-NS16 | 1.47 (37.3) | 0.85 (21.5) | 1.37 (34.9) | 1.48 (37.6) |
| 1 1/4 | 32 | 1 1/4 | -VM-AN20-NS20 | 1.59 (40.4) | 1.08 (27.5) | 1.69 (42.9) | 1.67 (42.4) |
| 1 1/2 | 38 | 1 1/2 | -VM-AN24-NS24 | 1.78 (45.2) | 1.30 (33.0) | 2.00 (50.8) | 1.77 (45.0) |
| 2 | 50 | 2 | -VM-AN32-NS32 | 2.22 (56.4) | 1.77 (45.0) | 2.50 (63.5) | 2.11 (53.6) |

Female Elbows

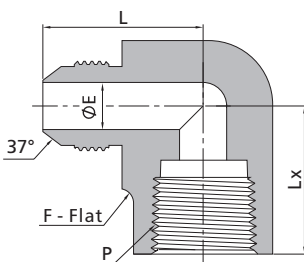

| SAE 070203 | | | | | | | |
|------------|----|------------|-----------------------|----------------------|-------------|-------------|-------------|
| Tube O.D. | | P-NPT Size | Basic Ordering Number | Dimensions, in. (mm) | | | |
| in. | mm | | | L | E | F | Lx |
| 1/8 | 3 | 1/8 | -LF-AN2-NS2 | 1.00 (25.4) | 0.06 (1.6) | 0.56 (14.3) | 0.66 (16.8) |
| 3/16 | 4 | 1/8 | -LF-AN3-NS2 | 1.03 (26.2) | 0.13 (3.2) | 0.56 (14.3) | 0.66 (16.8) |
| 1/4 | 6 | 1/8 | -LF-AN4-NS2 | 1.08 (27.4) | 0.17 (4.4) | 0.56 (14.3) | 0.66 (16.8) |
| 1/4 | 6 | 1/4 | -LF-AN4-NS4 | 1.22 (30.9) | 0.17 (4.4) | 0.81 (20.6) | 0.88 (22.4) |
| 5/16 | 8 | 1/8 | -LF-AN5-NS2 | 1.08 (27.4) | 0.24 (6.0) | 0.56 (14.3) | 0.66 (16.8) |
| 5/16 | 8 | 1/4 | -LF-AN5-NS4 | 1.22 (30.9) | 0.24 (6.0) | 0.81 (20.6) | 0.88 (22.4) |
| 3/8 | 10 | 1/8 | -LF-AN6-NS2 | 1.06 (26.9) | 0.30 (7.5) | 0.63 (15.9) | 0.66 (16.8) |
| 3/8 | 10 | 1/4 | -LF-AN6-NS4 | 1.23 (31.2) | 0.30 (7.5) | 0.81 (20.6) | 0.88 (22.4) |
| 3/8 | 10 | 3/8 | -LF-AN6-NS6 | 1.31 (33.2) | 0.30 (7.5) | 0.94 (23.8) | 1.02 (25.9) |
| 1/2 | 12 | 1/4 | -LF-AN8-NS4 | 1.24 (31.6) | 0.39 (9.9) | 0.81 (20.6) | 0.88 (22.4) |
| 1/2 | 12 | 3/8 | -LF-AN8-NS6 | 1.42 (36.1) | 0.39 (9.9) | 0.94 (23.8) | 1.02 (25.9) |
| 1/2 | 12 | 1/2 | -LF-AN8-NS8 | 1.42 (36.1) | 0.39 (9.9) | 1.06 (27.0) | 1.23 (31.2) |
| 5/8 | 16 | 1/2 | -LF-AN10-NS8 | 1.64 (41.7) | 0.48 (12.3) | 1.06 (27.0) | 1.23 (31.2) |
| 3/4 | 18 | 1/2 | -LF-AN12-NS8 | 1.66 (42.1) | 0.61 (15.5) | 1.25 (31.8) | 1.23 (31.2) |
| 3/4 | 18 | 3/4 | -LF-AN12-NS12 | 1.89 (48.0) | 0.61 (15.5) | 1.37 (34.9) | 1.36 (34.5) |
| 7/8 | 22 | 3/4 | -LF-AN14-NS12 | 1.86 (47.2) | 0.72 (18.3) | 1.37 (34.9) | 1.42 (36.1) |
| 1 | 25 | 1 | -LF-AN16-NS16 | 2.17 (55.1) | 0.85 (21.5) | 1.69 (42.9) | 1.62 (41.1) |
| 1 1/4 | 32 | 1 1/4 | -LF-AN20-NS20 | 2.33 (59.2) | 1.08 (27.5) | 2.00 (50.8) | 1.70 (43.2) |
| 1 1/2 | 38 | 1 1/2 | -LF-AN24-NS24 | 2.89 (73.4) | 1.30 (33.0) | 2.50 (63.5) | 2.08 (52.8) |
| 2 | 50 | 2 | -LF-AN32-NS32 | 3.30 (83.8) | 1.77 (45.0) | 2.50 (63.5) | 2.39 (60.7) |

11 37° Flared Tube Fitting

Union Elbows

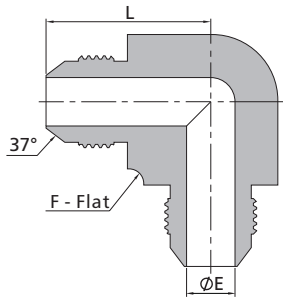

| SAE 070201 | | | | | |
|------------|----|-----------------------|----------------------|-------------|-------------|
| Tube O.D. | | Basic Ordering Number | Dimensions, in. (mm) | | |
| in. | mm | | L | E | F |
| 1/8 | 3 | -LU-AN2 | 0.77 (19.6) | 0.06 (1.6) | 0.44 (11.1) |
| 3/16 | 4 | -LU-AN3 | 0.83 (21.1) | 0.13 (3.2) | 0.44 (11.1) |
| 1/4 | 6 | -LU-AN4 | 0.89 (22.6) | 0.17 (4.4) | 0.50 (12.7) |
| 5/16 | 8 | -LU-AN5 | 0.95 (24.1) | 0.24 (6.0) | 0.56 (14.3) |
| 3/8 | 10 | -LU-AN6 | 1.06 (26.9) | 0.30 (7.5) | 0.56 (14.3) |
| 1/2 | 12 | -LU-AN8 | 1.25 (31.8) | 0.39 (9.9) | 0.81 (20.6) |
| 5/8 | 16 | -LU-AN10 | 1.45 (36.8) | 0.48 (12.3) | 0.81 (20.6) |
| 3/4 | 18 | -LU-AN12 | 1.66 (42.2) | 0.61 (15.5) | 1.06 (27.0) |
| 7/8 | 22 | -LU-AN14 | 1.80 (45.7) | 0.72 (18.3) | 1.25 (31.8) |
| 1 | 25 | -LU-AN16 | 1.81 (46.0) | 0.85 (21.5) | 1.37 (34.9) |
| 1 1/4 | 32 | -LU-AN20 | 2.06 (52.3) | 1.08 (27.5) | 1.69 (42.9) |
| 1 1/2 | 38 | -LU-AN24 | 2.33 (59.2) | 1.30 (33.0) | 2.00 (50.8) |
| 2 | 50 | -LU-AN32 | 3.06 (77.7) | 1.77 (45.0) | 2.50 (63.5) |

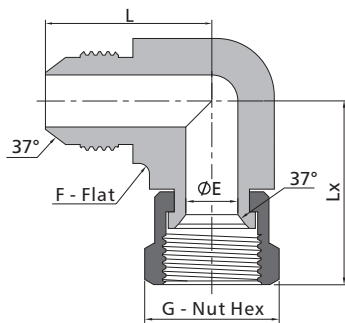

| SAE 070221 | | | | | | | | |
|------------|----|-----------------------|----------------------|-------------|-------------|-------------|-------------|--|
| Tube O.D. | | Basic Ordering Number | Dimensions, in. (mm) | | | | | |
| in. | mm | | L | E | F | Lx | G | |
| 1/8 | 3 | -LU-AN2-AS2 | 0.77 (19.6) | 0.06 (1.6) | 0.44 (11.1) | 0.97 (24.6) | 0.44 (11.1) | |
| 3/16 | 4 | -LU-AN3-AS3 | 0.83 (21.1) | 0.13 (3.2) | 0.44 (11.1) | 1.00 (25.4) | 0.50 (12.7) | |
| 1/4 | 6 | -LU-AN4-AS4 | 0.89 (22.6) | 0.17 (4.4) | 0.50 (12.7) | 1.00 (25.4) | 0.56 (14.3) | |
| 5/16 | 8 | -LU-AN5-AS5 | 0.95 (24.1) | 0.24 (6.0) | 0.56 (14.3) | 1.06 (26.9) | 0.63 (15.9) | |
| 3/8 | 10 | -LU-AN6-AS6 | 1.06 (26.9) | 0.30 (7.5) | 0.56 (14.3) | 1.25 (31.8) | 0.69 (17.5) | |
| 1/2 | 12 | -LU-AN8-AS8 | 1.25 (31.8) | 0.39 (9.9) | 0.81 (20.6) | 1.38 (35.1) | 0.87 (22.2) | |
| 5/8 | 16 | -LU-AN10-AS10 | 1.45 (36.8) | 0.48 (12.3) | 0.81 (20.6) | 1.62 (41.1) | 1.00 (25.4) | |
| 3/4 | 18 | -LU-AN12-AS12 | 1.66 (42.2) | 0.61 (15.5) | 1.06 (27.0) | 1.75 (44.4) | 1.25 (31.8) | |
| 7/8 | 22 | -LU-AN14-AS14 | 1.80 (45.7) | 0.72 (18.3) | 1.25 (31.8) | 1.78 (45.2) | 1.37 (34.9) | |
| 1 | 25 | -LU-AN16-AS16 | 1.81 (46.0) | 0.85 (21.5) | 1.37 (34.9) | 2.00 (50.8) | 1.50 (38.1) | |
| 1 1/4 | 32 | -LU-AN20-AS20 | 2.06 (52.3) | 1.08 (27.5) | 1.69 (42.9) | 2.31 (58.7) | 2.00 (50.8) | |
| 1 1/2 | 38 | -LU-AN24-AS24 | 2.33 (59.2) | 1.30 (33.0) | 2.00 (50.8) | 2.59 (65.8) | 2.37 (60.3) | |
| 2 | 50 | -LU-AN32-AS32 | 3.06 (77.7) | 1.77 (45.0) | 2.50 (63.5) | 3.38 (85.9) | 2.87 (73.0) | |

Male Branch Tees

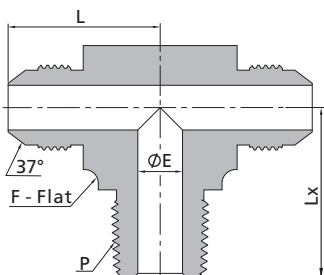

| SAE 070425 | | | | | | | |
|------------|----|------------|-----------------------|----------------------|-------------|-------------|-------------|
| Tube O.D. | | P-NPT Size | Basic Ordering Number | Dimensions, in. (mm) | | | |
| in. | mm | | | L | E | F | Lx |
| 1/8 | 3 | 1/8 | -TTM-AN2-NS2 | 0.77 (19.6) | 0.06 (1.6) | 0.44 (11.1) | 0.72 (18.3) |
| 3/16 | 4 | 1/8 | -TTM-AN3-NS2 | 0.83 (21.1) | 0.13 (3.2) | 0.44 (11.1) | 0.72 (18.3) |
| 1/4 | 6 | 1/8 | -TTM-AN4-NS2 | 0.89 (22.6) | 0.17 (4.4) | 0.50 (12.7) | 0.78 (19.8) |
| 1/4 | 6 | 1/4 | -TTM-AN4-NS4 | 1.06 (26.9) | 0.17 (4.4) | 0.56 (14.3) | 1.09 (27.7) |
| 5/16 | 8 | 1/8 | -TTM-AN5-NS2 | 0.95 (24.1) | 0.19 (4.8) | 0.56 (14.3) | 0.78 (19.8) |
| 5/16 | 8 | 1/4 | -TTM-AN5-NS4 | 1.06 (26.9) | 0.24 (6.0) | 0.56 (14.3) | 1.09 (27.7) |
| 3/8 | 10 | 1/8 | -TTM-AN6-NS2 | 1.06 (26.9) | 0.19 (4.8) | 0.56 (14.3) | 0.90 (22.8) |
| 3/8 | 10 | 1/4 | -TTM-AN6-NS4 | 1.06 (26.9) | 0.28 (7.1) | 0.56 (14.3) | 1.09 (27.7) |
| 3/8 | 10 | 3/8 | -TTM-AN6-NS6 | 1.14 (29.0) | 0.30 (7.5) | 0.69 (17.5) | 1.22 (31.0) |
| 3/8 | 10 | 1/2 | -TTM-AN6-NS8 | 1.23 (31.2) | 0.30 (7.5) | 0.81 (20.6) | 1.47 (37.3) |
| 1/2 | 12 | 1/4 | -TTM-AN8-NS4 | 1.25 (31.8) | 0.28 (7.1) | 0.81 (20.6) | 1.22 (31.0) |
| 1/2 | 12 | 3/8 | -TTM-AN8-NS6 | 1.25 (31.8) | 0.39 (9.9) | 0.81 (20.6) | 1.22 (31.0) |
| 1/2 | 12 | 1/2 | -TTM-AN8-NS8 | 1.33 (33.7) | 0.39 (9.9) | 0.81 (20.6) | 1.47 (37.3) |
| 1/2 | 12 | 3/4 | -TTM-AN8-NS12 | 1.42 (36.0) | 0.39 (9.9) | 1.00 (25.4) | 1.59 (40.4) |
| 5/8 | 16 | 3/8 | -TTM-AN10-NS6 | 1.45 (36.8) | 0.39 (9.9) | 0.81 (20.6) | 1.30 (33.0) |
| 5/8 | 16 | 1/2 | -TTM-AN10-NS8 | 1.45 (36.8) | 0.48 (12.3) | 0.81 (20.6) | 1.47 (37.3) |
| 5/8 | 16 | 3/4 | -TTM-AN10-NS12 | 1.53 (38.9) | 0.48 (12.3) | 1.00 (25.4) | 1.59 (40.4) |
| 3/4 | 18 | 3/4 | -TTM-AN12-NS12 | 1.66 (42.2) | 0.61 (15.5) | 1.06 (27.0) | 1.59 (40.4) |
| 3/4 | 18 | 1 | -TTM-AN12-NS16 | 1.66 (42.2) | 0.61 (15.5) | 1.25 (31.8) | 1.98 (50.4) |
| 7/8 | 22 | 3/4 | -TTM-AN14-NS12 | 1.80 (45.7) | 0.72 (18.3) | 1.25 (31.8) | 1.69 (42.9) |
| 1 | 25 | 3/4 | -TTM-AN16-NS12 | 1.81 (46.0) | 0.72 (18.3) | 1.37 (34.9) | 1.78 (45.2) |
| 1 | 25 | 1 | -TTM-AN16-NS16 | 1.81 (46.0) | 0.85 (21.5) | 1.37 (34.9) | 1.97 (50.0) |
| 1 1/4 | 32 | 1 | -TTM-AN20-NS16 | 2.06 (52.3) | 0.94 (23.8) | 1.69 (42.9) | 2.35 (59.6) |
| 1 1/4 | 32 | 1 1/4 | -TTM-AN20-NS20 | 2.06 (52.3) | 1.08 (27.5) | 1.69 (42.9) | 2.38 (60.5) |
| 1 1/2 | 38 | 1 1/2 | -TTM-AN24-NS24 | 2.33 (59.2) | 1.30 (33.0) | 2.00 (50.8) | 2.64 (67.1) |
| 2 | 50 | 2 | -TTM-AN32-NS32 | 3.06 (77.7) | 1.77 (45.0) | 2.50 (63.5) | 3.00 (76.2) |

Adjustable Male Branch Tees

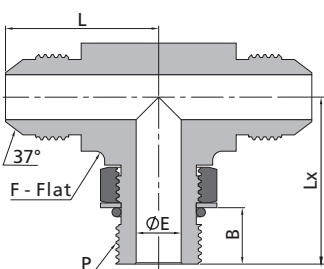

| SAE 070429 | | | | | | | | |
|------------|----|----------------------|-----------------------|----------------------|-------------|-------------|-------------|-------------|
| Tube O.D. | | P-SAE/MS Thread Size | Basic Ordering Number | Dimensions, in. (mm) | | | | |
| in. | mm | | | L | E | F | Lx | B |
| 1/8 | 3 | 5/16-24 | -TTP-AN2-ST5 | 0.77 (19.6) | 0.06 (1.6) | 0.44 (11.1) | 0.94 (23.9) | 0.33 (8.4) |
| 3/16 | 4 | 3/8-24 | -TTP-AN3-ST6 | 0.83 (21.1) | 0.13 (3.2) | 0.44 (11.1) | 0.94 (23.9) | 0.33 (8.4) |
| 1/4 | 6 | 7/16-20 | -TTP-AN4-ST7 | 0.89 (22.6) | 0.17 (4.4) | 0.50 (12.7) | 1.03 (26.2) | 0.39 (9.8) |
| 5/16 | 8 | 1/2-20 | -TTP-AN5-ST8 | 0.95 (24.1) | 0.24 (6.0) | 0.56 (14.3) | 1.13 (28.7) | 0.39 (9.8) |
| 3/8 | 10 | 9/16-18 | -TTP-AN6-ST9 | 1.06 (26.9) | 0.30 (7.5) | 0.63 (15.9) | 1.25 (31.8) | 0.43 (11.0) |
| 1/2 | 12 | 3/4-16 | -TTP-AN8-ST12 | 1.25 (31.8) | 0.39 (9.9) | 0.81 (20.6) | 1.45 (36.8) | 0.49 (12.5) |
| 5/8 | 16 | 7/8-14 | -TTP-AN10-ST14 | 1.45 (36.8) | 0.48 (12.3) | 0.94 (23.8) | 1.70 (43.2) | 0.56 (14.2) |
| 3/4 | 18 | 1 1/16-12 | -TTP-AN12-ST17 | 1.66 (42.2) | 0.61 (15.5) | 1.25 (31.8) | 1.94 (49.3) | 0.65 (16.5) |
| 7/8 | 22 | 1 3/16-12 | -TTP-AN14-ST19 | 1.80 (45.7) | 0.72 (18.3) | 1.25 (31.8) | 2.00 (50.8) | 0.65 (16.5) |
| 1 | 25 | 1 5/16-12 | -TTP-AN16-ST21 | 1.81 (46.0) | 0.85 (21.5) | 1.37 (34.9) | 2.05 (52.1) | 0.65 (16.5) |
| 1 1/4 | 32 | 1 5/8-12 | -TTP-AN20-ST26 | 2.06 (52.3) | 1.08 (27.5) | 1.69 (42.9) | 2.25 (57.2) | 0.65 (16.5) |
| 1 1/2 | 38 | 1 7/8-12 | -TTP-AN24-ST30 | 2.33 (59.2) | 1.30 (33.0) | 2.00 (50.8) | 2.39 (60.7) | 0.65 (16.5) |
| 2 | 50 | 2 1/2-12 | -TTP-AN32-ST40 | 3.06 (77.7) | 1.77 (45.0) | 2.50 (63.5) | 2.89 (73.4) | 0.65 (16.5) |

Male Run Tees

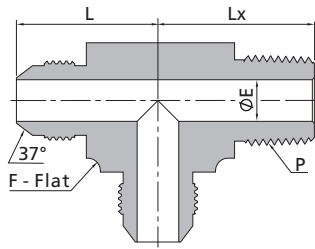

| SAE 070424 | | | | | | | |
|------------|----|------------|-----------------------|----------------------|-------------|-------------|-------------|
| Tube O.D. | | P-NPT Size | Basic Ordering Number | Dimensions, in. (mm) | | | |
| in. | mm | | | L | E | F | Lx |
| 1/8 | 3 | 1/8 | -TMT-AN2-NS2 | 0.77 (19.6) | 0.06 (1.6) | 0.44 (11.1) | 0.72 (18.3) |
| 3/16 | 4 | 1/8 | -TMT-AN3-NS2 | 0.83 (21.1) | 0.13 (3.2) | 0.44 (11.1) | 0.72 (18.3) |
| 1/4 | 6 | 1/8 | -TMT-AN4-NS2 | 0.89 (22.6) | 0.17 (4.4) | 0.50 (12.7) | 0.78 (19.8) |
| 1/4 | 6 | 1/4 | -TMT-AN4-NS4 | 1.06 (26.9) | 0.17 (4.4) | 0.56 (14.3) | 1.09 (27.7) |
| 5/16 | 8 | 1/8 | -TMT-AN5-NS2 | 0.95 (24.1) | 0.19 (4.8) | 0.56 (14.3) | 0.78 (19.8) |
| 5/16 | 8 | 1/4 | -TMT-AN5-NS4 | 1.06 (26.9) | 0.24 (6.0) | 0.56 (14.3) | 1.09 (27.7) |
| 3/8 | 10 | 1/8 | -TMT-AN6-NS2 | 1.06 (26.9) | 0.19 (4.8) | 0.56 (14.3) | 0.90 (22.8) |
| 3/8 | 10 | 1/4 | -TMT-AN6-NS4 | 1.06 (26.9) | 0.28 (7.1) | 0.56 (14.3) | 1.09 (27.7) |
| 3/8 | 10 | 3/8 | -TMT-AN6-NS6 | 1.14 (29.0) | 0.30 (7.5) | 0.69 (17.5) | 1.22 (31.0) |
| 3/8 | 10 | 1/2 | -TMT-AN6-NS8 | 1.23 (31.2) | 0.30 (7.5) | 0.81 (20.6) | 1.47 (37.3) |
| 1/2 | 12 | 1/4 | -TMT-AN8-NS4 | 1.25 (31.8) | 0.28 (7.1) | 0.81 (20.6) | 1.22 (31.0) |
| 1/2 | 12 | 3/8 | -TMT-AN8-NS6 | 1.25 (31.8) | 0.39 (9.9) | 0.81 (20.6) | 1.22 (31.0) |
| 1/2 | 12 | 1/2 | -TMT-AN8-NS8 | 1.33 (33.7) | 0.39 (9.9) | 0.81 (20.6) | 1.47 (37.3) |
| 1/2 | 12 | 3/4 | -TMT-AN8-NS12 | 1.42 (36.0) | 0.39 (9.9) | 1.00 (25.4) | 1.59 (40.4) |
| 5/8 | 16 | 3/8 | -TMT-AN10-NS6 | 1.45 (36.8) | 0.39 (9.9) | 0.81 (20.6) | 1.30 (33.0) |
| 5/8 | 16 | 1/2 | -TMT-AN10-NS8 | 1.45 (36.8) | 0.48 (12.3) | 0.81 (20.6) | 1.47 (37.3) |
| 5/8 | 16 | 3/4 | -TMT-AN10-NS12 | 1.53 (38.9) | 0.48 (12.3) | 1.00 (25.4) | 1.59 (40.4) |
| 3/4 | 18 | 3/4 | -TMT-AN12-NS12 | 1.66 (42.2) | 0.61 (15.5) | 1.06 (27.0) | 1.59 (40.4) |
| 3/4 | 18 | 1 | -TMT-AN12-NS16 | 1.66 (42.2) | 0.61 (15.5) | 1.25 (31.8) | 1.98 (50.4) |
| 7/8 | 22 | 3/4 | -TMT-AN14-NS12 | 1.80 (45.7) | 0.72 (18.3) | 1.25 (31.8) | 1.69 (42.9) |
| 1 | 25 | 3/4 | -TMT-AN16-NS12 | 1.81 (46.0) | 0.72 (18.3) | 1.37 (34.9) | 1.78 (45.2) |
| 1 | 25 | 1 | -TMT-AN16-NS16 | 1.81 (46.0) | 0.85 (21.5) | 1.37 (34.9) | 1.97 (50.0) |
| 1 1/4 | 32 | 1 | -TMT-AN20-NS16 | 2.06 (52.3) | 0.94 (23.8) | 1.69 (42.9) | 2.35 (59.6) |
| 1 1/4 | 32 | 1 1/4 | -TMT-AN20-NS20 | 2.06 (52.3) | 1.08 (27.5) | 1.69 (42.9) | 2.38 (60.5) |
| 1 1/2 | 38 | 1 1/2 | -TMT-AN24-NS24 | 2.33 (59.2) | 1.30 (33.0) | 2.00 (50.8) | 2.64 (67.1) |
| 2 | 50 | 2 | -TMT-AN32-NS32 | 3.06 (77.7) | 1.77 (45.0) | 2.50 (63.5) | 3.00 (76.2) |

Female Branch Tees

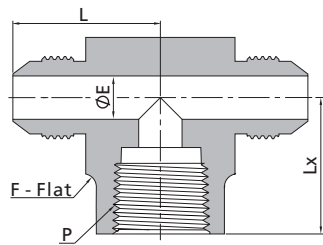

| SAE 070427 | | | | | | | |
|------------|----|------------|-----------------------|----------------------|-------------|-------------|-------------|
| Tube O.D. | | P-NPT Size | Basic Ordering Number | Dimensions, in. (mm) | | | |
| in. | mm | | | L | E | F | Lx |
| 1/8 | 3 | 1/8 | -TTF-AN2-NS2 | 1.00 (25.4) | 0.06 (1.6) | 0.56 (14.3) | 0.66 (16.8) |
| 3/16 | 4 | 1/8 | -TTF-AN3-NS2 | 1.03 (26.2) | 0.13 (3.2) | 0.56 (14.3) | 0.66 (16.8) |
| 1/4 | 6 | 1/8 | -TTF-AN4-NS2 | 1.08 (27.4) | 0.17 (4.4) | 0.56 (14.3) | 0.66 (16.8) |
| 1/4 | 6 | 1/4 | -TTF-AN4-NS4 | 1.22 (30.9) | 0.17 (4.4) | 0.81 (20.6) | 0.88 (22.4) |
| 5/16 | 8 | 1/8 | -TTF-AN5-NS2 | 1.08 (27.4) | 0.24 (6.0) | 0.56 (14.3) | 0.66 (16.8) |
| 5/16 | 8 | 1/4 | -TTF-AN5-NS4 | 1.22 (30.9) | 0.24 (6.0) | 0.81 (20.6) | 0.88 (22.4) |
| 3/8 | 10 | 1/8 | -TTF-AN6-NS2 | 1.06 (26.9) | 0.30 (7.5) | 0.63 (15.9) | 0.66 (16.8) |
| 3/8 | 10 | 1/4 | -TTF-AN6-NS4 | 1.23 (31.2) | 0.30 (7.5) | 0.81 (20.6) | 0.88 (22.4) |
| 3/8 | 10 | 3/8 | -TTF-AN6-NS6 | 1.31 (33.2) | 0.30 (7.5) | 0.94 (23.8) | 1.02 (25.9) |
| 1/2 | 12 | 1/4 | -TTF-AN8-NS4 | 1.24 (31.6) | 0.39 (9.9) | 0.81 (20.6) | 0.88 (22.4) |
| 1/2 | 12 | 3/8 | -TTF-AN8-NS6 | 1.42 (36.1) | 0.39 (9.9) | 0.94 (23.8) | 1.02 (25.9) |
| 1/2 | 12 | 1/2 | -TTF-AN8-NS8 | 1.42 (36.1) | 0.39 (9.9) | 1.06 (27.0) | 1.23 (31.2) |
| 5/8 | 16 | 1/2 | -TTF-AN10-NS8 | 1.64 (41.7) | 0.48 (12.3) | 1.06 (27.0) | 1.23 (31.2) |
| 3/4 | 18 | 1/2 | -TTF-AN12-NS8 | 1.66 (42.1) | 0.61 (15.5) | 1.25 (31.8) | 1.23 (31.2) |
| 3/4 | 18 | 3/4 | -TTF-AN12-NS12 | 1.89 (48.0) | 0.61 (15.5) | 1.37 (34.9) | 1.36 (34.5) |
| 7/8 | 22 | 3/4 | -TTF-AN14-NS12 | 1.86 (47.2) | 0.72 (18.3) | 1.37 (34.9) | 1.42 (36.1) |
| 1 | 25 | 1 | -TTF-AN16-NS16 | 2.17 (55.1) | 0.85 (21.5) | 1.69 (42.9) | 1.62 (41.1) |
| 1 1/4 | 32 | 1 1/4 | -TTF-AN20-NS20 | 2.33 (59.2) | 1.08 (27.5) | 2.00 (50.8) | 1.70 (43.2) |
| 1 1/2 | 38 | 1 1/2 | -TTF-AN24-NS24 | 2.89 (73.4) | 1.30 (33.0) | 2.50 (63.5) | 2.08 (52.8) |
| 2 | 50 | 2 | -TTF-AN32-NS32 | 3.30 (83.8) | 1.77 (45.0) | 2.50 (63.5) | 2.39 (60.7) |

Female Run Tees

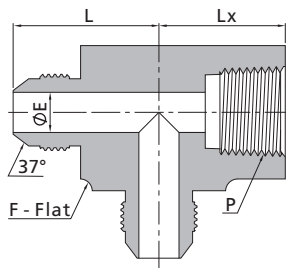

| SAE 070426 | | | | | | | |
|------------|----|------------|-----------------------|----------------------|-------------|-------------|-------------|
| Tube O.D. | | P-NPT Size | Basic Ordering Number | Dimensions, in. (mm) | | | |
| in. | mm | | | L | E | F | Lx |
| 1/8 | 3 | 1/8 | -TFT-AN2-NS2 | 1.00 (25.4) | 0.06 (1.6) | 0.56 (14.3) | 0.66 (16.8) |
| 3/16 | 4 | 1/8 | -TFT-AN3-NS2 | 1.03 (26.2) | 0.13 (3.2) | 0.56 (14.3) | 0.66 (16.8) |
| 1/4 | 6 | 1/8 | -TFT-AN4-NS2 | 1.08 (27.4) | 0.17 (4.4) | 0.56 (14.3) | 0.66 (16.8) |
| 1/4 | 6 | 1/4 | -TFT-AN4-NS4 | 1.22 (30.9) | 0.17 (4.4) | 0.81 (20.6) | 0.88 (22.4) |
| 5/16 | 8 | 1/8 | -TFT-AN5-NS2 | 1.08 (27.4) | 0.24 (6.0) | 0.56 (14.3) | 0.66 (16.8) |
| 5/16 | 8 | 1/4 | -TFT-AN5-NS4 | 1.22 (30.9) | 0.24 (6.0) | 0.81 (20.6) | 0.88 (22.4) |
| 3/8 | 10 | 1/8 | -TFT-AN6-NS2 | 1.06 (26.9) | 0.30 (7.5) | 0.63 (15.9) | 0.66 (16.8) |
| 3/8 | 10 | 1/4 | -TFT-AN6-NS4 | 1.23 (31.2) | 0.30 (7.5) | 0.81 (20.6) | 0.88 (22.4) |
| 3/8 | 10 | 3/8 | -TFT-AN6-NS6 | 1.31 (33.2) | 0.30 (7.5) | 0.94 (23.8) | 1.02 (25.9) |
| 1/2 | 12 | 1/4 | -TFT-AN8-NS4 | 1.24 (31.6) | 0.39 (9.9) | 0.81 (20.6) | 0.88 (22.4) |
| 1/2 | 12 | 3/8 | -TFT-AN8-NS6 | 1.42 (36.1) | 0.39 (9.9) | 0.94 (23.8) | 1.02 (25.9) |
| 1/2 | 12 | 1/2 | -TFT-AN8-NS8 | 1.42 (36.1) | 0.39 (9.9) | 1.06 (27.0) | 1.23 (31.2) |
| 5/8 | 16 | 1/2 | -TFT-AN10-NS8 | 1.64 (41.7) | 0.48 (12.3) | 1.06 (27.0) | 1.23 (31.2) |
| 3/4 | 18 | 1/2 | -TFT-AN12-NS8 | 1.66 (42.1) | 0.61 (15.5) | 1.25 (31.8) | 1.23 (31.2) |
| 3/4 | 18 | 3/4 | -TFT-AN12-NS12 | 1.89 (48.0) | 0.61 (15.5) | 1.37 (34.9) | 1.36 (34.5) |
| 7/8 | 22 | 3/4 | -TFT-AN14-NS12 | 1.86 (47.2) | 0.72 (18.3) | 1.37 (34.9) | 1.42 (36.1) |
| 1 | 25 | 1 | -TFT-AN16-NS16 | 2.17 (55.1) | 0.85 (21.5) | 1.69 (42.9) | 1.62 (41.1) |
| 1 1/4 | 32 | 1 1/4 | -TFT-AN20-NS20 | 2.33 (59.2) | 1.08 (27.5) | 2.00 (50.8) | 1.70 (43.2) |
| 1 1/2 | 38 | 1 1/2 | -TFT-AN24-NS24 | 2.89 (73.4) | 1.30 (33.0) | 2.50 (63.5) | 2.08 (52.8) |
| 2 | 50 | 2 | -TFT-AN32-NS32 | 3.30 (83.8) | 1.77 (45.0) | 2.50 (63.5) | 2.39 (60.7) |

Union Tees

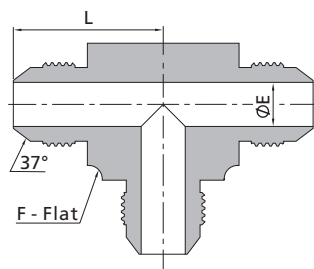

| SAE 070401 | | | | | |
|------------|----|-----------------------|----------------------|-------------|-------------|
| Tube O.D. | | Basic Ordering Number | Dimensions, in. (mm) | | |
| in. | mm | | L | E | F |
| 1/8 | 3 | -TTT-AN2 | 0.77 (19.6) | 0.06 (1.6) | 0.44 (11.1) |
| 3/16 | 4 | -TTT-AN3 | 0.83 (21.1) | 0.13 (3.2) | 0.44 (11.1) |
| 1/4 | 6 | -TTT-AN4 | 0.89 (22.6) | 0.17 (4.4) | 0.50 (12.7) |
| 5/16 | 8 | -TTT-AN5 | 0.95 (24.1) | 0.24 (6.0) | 0.56 (14.3) |
| 3/8 | 10 | -TTT-AN6 | 1.06 (26.9) | 0.30 (7.5) | 0.56 (14.3) |
| 1/2 | 12 | -TTT-AN8 | 1.25 (31.8) | 0.39 (9.9) | 0.81 (20.6) |
| 5/8 | 16 | -TTT-AN10 | 1.45 (36.8) | 0.48 (12.3) | 0.81 (20.6) |
| 3/4 | 18 | -TTT-AN12 | 1.66 (42.2) | 0.61 (15.5) | 1.06 (27.0) |
| 7/8 | 22 | -TTT-AN14 | 1.80 (45.7) | 0.72 (18.3) | 1.25 (31.8) |
| 1 | 25 | -TTT-AN16 | 1.81 (46.0) | 0.85 (21.5) | 1.37 (34.9) |
| 1 1/4 | 32 | -TTT-AN20 | 2.06 (52.3) | 1.08 (27.5) | 1.69 (42.9) |
| 1 1/2 | 38 | -TTT-AN24 | 2.33 (59.2) | 1.30 (33.0) | 2.00 (50.8) |
| 2 | 50 | -TTT-AN32 | 3.06 (77.7) | 1.77 (45.0) | 2.50 (63.5) |

Union Tees

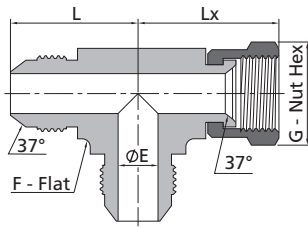

| SAE 070432 | | | | | | | | |
|------------|----|-----------------------|----------------------|-------------|-------------|-------------|-------------|--|
| Tube O.D. | | Basic Ordering Number | Dimensions, in. (mm) | | | | | |
| in. | mm | | L | E | F | Lx | G | |
| 1/8 | 3 | -TTT-AN2-AS2-AN2 | 0.77 (19.6) | 0.06 (1.6) | 0.44 (11.1) | 0.97 (24.6) | 0.44 (11.1) | |
| 3/16 | 4 | -TTT-AN3-AS3-AN3 | 0.83 (21.1) | 0.13 (3.2) | 0.44 (11.1) | 1.00 (25.4) | 0.50 (12.7) | |
| 1/4 | 6 | -TTT-AN4-AS4-AN4 | 0.89 (22.6) | 0.17 (4.4) | 0.50 (12.7) | 1.00 (25.4) | 0.56 (14.3) | |
| 5/16 | 8 | -TTT-AN5-AS5-AN5 | 0.95 (24.1) | 0.24 (6.0) | 0.56 (14.3) | 1.06 (26.9) | 0.63 (15.9) | |
| 3/8 | 10 | -TTT-AN6-AS6-AN6 | 1.06 (26.9) | 0.30 (7.5) | 0.56 (14.3) | 1.25 (31.8) | 0.69 (17.5) | |
| 1/2 | 12 | -TTT-AN8-AS8-AN8 | 1.25 (31.8) | 0.39 (9.9) | 0.81 (20.6) | 1.38 (35.1) | 0.87 (22.2) | |
| 5/8 | 16 | -TTT-AN10-AS10-AN10 | 1.45 (36.8) | 0.48 (12.3) | 0.81 (20.6) | 1.62 (41.1) | 1.00 (25.4) | |
| 3/4 | 18 | -TTT-AN12-AS12-AN12 | 1.66 (42.2) | 0.61 (15.5) | 1.06 (27.0) | 1.75 (44.4) | 1.25 (31.8) | |
| 7/8 | 22 | -TTT-AN14-AS14-AN14 | 1.80 (45.7) | 0.72 (18.3) | 1.25 (31.8) | 1.78 (45.2) | 1.37 (34.9) | |
| 1 | 25 | -TTT-AN16-AS16-AN16 | 1.81 (46.0) | 0.85 (21.5) | 1.37 (34.9) | 2.00 (50.8) | 1.50 (38.1) | |
| 1 1/4 | 32 | -TTT-AN20-AS20-AN20 | 2.06 (52.3) | 1.08 (27.5) | 1.69 (42.9) | 2.31 (58.7) | 2.00 (50.8) | |
| 1 1/2 | 38 | -TTT-AN24-AS24-AN24 | 2.33 (59.2) | 1.30 (33.0) | 2.00 (50.8) | 2.59 (65.8) | 2.37 (60.3) | |
| 2 | 50 | -TTT-AN32-AS32-AN32 | 3.06 (77.7) | 1.77 (45.0) | 2.50 (63.5) | 3.38 (85.9) | 2.87 (73.0) | |

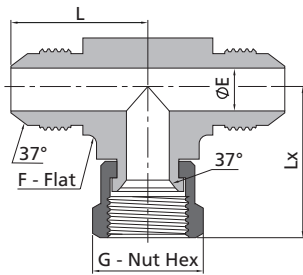

| SAE 070433 | | | | | | | | |
|------------|----|-----------------------|----------------------|-------------|-------------|-------------|-------------|--|
| Tube O.D. | | Basic Ordering Number | Dimensions, in. (mm) | | | | | |
| in. | mm | | L | E | F | Lx | G | |
| 1/8 | 3 | -TTT-AN2-AN2-AS2 | 0.77 (19.6) | 0.06 (1.6) | 0.44 (11.1) | 0.97 (24.6) | 0.44 (11.1) | |
| 3/16 | 4 | -TTT-AN3-AN3-AS3 | 0.83 (21.1) | 0.13 (3.2) | 0.44 (11.1) | 1.00 (25.4) | 0.50 (12.7) | |
| 1/4 | 6 | -TTT-AN4-AN4-AS4 | 0.89 (22.6) | 0.17 (4.4) | 0.50 (12.7) | 1.00 (25.4) | 0.56 (14.3) | |
| 5/16 | 8 | -TTT-AN5-AN5-AS5 | 0.95 (24.1) | 0.24 (6.0) | 0.56 (14.3) | 1.06 (26.9) | 0.63 (15.9) | |
| 3/8 | 10 | -TTT-AN6-AN6-AS6 | 1.06 (26.9) | 0.30 (7.5) | 0.56 (14.3) | 1.25 (31.8) | 0.69 (17.5) | |
| 1/2 | 12 | -TTT-AN8-AN8-AS8 | 1.25 (31.8) | 0.39 (9.9) | 0.81 (20.6) | 1.38 (35.1) | 0.87 (22.2) | |
| 5/8 | 16 | -TTT-AN10-AN10-AS10 | 1.45 (36.8) | 0.48 (12.3) | 0.81 (20.6) | 1.62 (41.1) | 1.00 (25.4) | |
| 3/4 | 18 | -TTT-AN12-AN12-AS12 | 1.66 (42.2) | 0.61 (15.5) | 1.06 (27.0) | 1.75 (44.4) | 1.25 (31.8) | |
| 7/8 | 22 | -TTT-AN14-AN14-AS14 | 1.80 (45.7) | 0.72 (18.3) | 1.25 (31.8) | 1.78 (45.2) | 1.37 (34.9) | |
| 1 | 25 | -TTT-AN16-AN16-AS16 | 1.81 (46.0) | 0.85 (21.5) | 1.37 (34.9) | 2.00 (50.8) | 1.50 (38.1) | |
| 1 1/4 | 32 | -TTT-AN20-AN20-AS20 | 2.06 (52.3) | 1.08 (27.5) | 1.69 (42.9) | 2.31 (58.7) | 2.00 (50.8) | |
| 1 1/2 | 38 | -TTT-AN24-AN24-AS24 | 2.33 (59.2) | 1.30 (33.0) | 2.00 (50.8) | 2.59 (65.8) | 2.37 (60.3) | |
| 2 | 50 | -TTT-AN32-AN32-AS32 | 3.06 (77.7) | 1.77 (45.0) | 2.50 (63.5) | 3.38 (85.9) | 2.87 (73.0) | |

Union Crosses

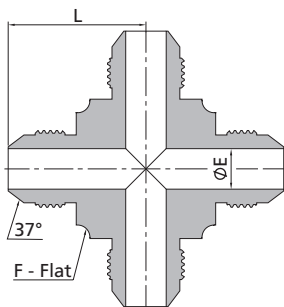

| SAE 070501 | | | | | | |
|------------|----|-----------------------|----------------------|-------------|-------------|--|
| Tube O.D. | | Basic Ordering Number | Dimensions, in. (mm) | | | |
| in. | mm | | L | E | F | |
| 1/8 | 3 | -C-AN2 | 0.77 (19.6) | 0.06 (1.6) | 0.44 (11.1) | |
| 3/16 | 4 | -C-AN3 | 0.83 (21.1) | 0.13 (3.2) | 0.44 (11.1) | |
| 1/4 | 6 | -C-AN4 | 0.89 (22.6) | 0.17 (4.4) | 0.50 (12.7) | |
| 5/16 | 8 | -C-AN5 | 0.95 (24.1) | 0.24 (6.0) | 0.56 (14.3) | |
| 3/8 | 10 | -C-AN6 | 1.06 (26.9) | 0.30 (7.5) | 0.56 (14.3) | |
| 1/2 | 12 | -C-AN8 | 1.25 (31.8) | 0.39 (9.9) | 0.81 (20.6) | |
| 5/8 | 16 | -C-AN10 | 1.45 (36.8) | 0.48 (12.3) | 0.81 (20.6) | |
| 3/4 | 18 | -C-AN12 | 1.66 (42.2) | 0.61 (15.5) | 1.06 (27.0) | |
| 7/8 | 22 | -C-AN14 | 1.80 (45.7) | 0.72 (18.3) | 1.25 (31.8) | |
| 1 | 25 | -C-AN16 | 1.81 (46.0) | 0.85 (21.5) | 1.37 (34.9) | |
| 1 1/4 | 32 | -C-AN20 | 2.06 (52.3) | 1.08 (27.5) | 1.69 (42.9) | |
| 1 1/2 | 38 | -C-AN24 | 2.33 (59.2) | 1.30 (33.0) | 2.00 (50.8) | |
| 2 | 50 | -C-AN32 | 3.06 (77.7) | 1.77 (45.0) | 2.50 (63.5) | |

Nantong ROKE Fluid Equipment Co.,LTD

ROKE Factory

Pingchao Town, Tongzhou Area

Nantong City, Jiangsu Province,China

Tel:86-513-85400443 **Fax:**86-513-85400444

ROKE Office

Room 1108 .Building B. Jianghaicaifudasha

No.817.Jianghai Avenue.Gangzha Area

Nantong City, Jiangsu Province,China

Web:www.chinaroke.com **E-mail:**sales01@ntroke.com

ROKE

Valves and Fittings

www.chinaroke.com